



BPAWEIS Ignition System

BATTERY POWERED ALL WEATHER ELECTRONIC IGNITION SYSTEM > INSTRUCTIONS

Models Covered in this Instruction Set



290k

Battery Models

- > BPAWEISNG
290k BTU | Battery | Natural Gas
- > BPAWEISLP
290k BTU | Battery | Liquid Propane
- > BPAWEISNG-BT
290k BTU | Battery | Natural Gas
- > BPAWEISLP-BT
290k BTU | Battery | Liquid Propane

Product Certifications

This QR Code will always take you to the most recent certifications for the entire Fire by Design product line.

You can also type in the URL directly: <http://fbdqr.com/product-certs>



WARNING: For Outdoor Use Only



STOP: If you cannot read or understand these instructions, do **NOT** attempt to install or operate this appliance.



STOP:

IF YOU SMELL GAS

- Shut off gas to the appliance
- Extinguish any open flame
- If odor continues, keep away from the appliance and immediately call your gas supplier or fire department

INSTALLER: Leave this manual with the appliance.
CONSUMER: Retain this manual for future reference.

Proposition 65 Warning

Operating, servicing and maintaining this appliance can expose you to chemicals including Carbon Monoxide and Lead which are known to the State of California to cause cancer, birth defects or other reproductive harm. For more information go to www.Prop65Warnings.ca.gov



WARNING

Improper installation, adjustment, alteration, service or maintenance can cause injury or property damage. Read the installation, operating and maintenance instructions thoroughly before installing or servicing this equipment



WARNING

For use with NATURAL or LP GAS Only
NO SOLID FUELS TO BE USED WITH THIS SYSTEM

WARNING

Do not store or use gasoline or other flammable vapors and liquids in vicinity of this or any other appliance.
An LP-cylinder not connected for use shall not be stored in the vicinity of this or any other appliance.

CARBON MONOXIDE HAZARD

This appliance can produce carbon monoxide which has no odor.

Using it in an enclosed space can kill you.

Never use this appliance in an enclosed space such as a camper, tent, car or home.

Installation must conform with local codes or, in the absence of local codes, with the National Fuel Gas Code, ANSI Z223.1 / NFPA 54, or International Fuel Gas Code.

The appliance, when installed, must be electrically grounded in accordance with local codes or, in the absence of local codes, with the National Electric Code, ANSI/NFPA 70, if applicable.



AVERTISSEMENT

Ne pas entreposer ni utiliser de l'essence ni d'autres vapeurs ou liquides inflammables dans le voisinage de l'appareil, ni de tout autre appareil.

Une bouteille de propane qui n'est pas raccordée en vue de son utilisation, ne doit pas être entreposée dans le voisinage de cet appareil ou de tout autre appareil.



AVERTISSEMENT

Une installation, un ajustement, une modification, une réparation ou un entretien inapproprié peuvent être la cause de blessures ou de dommages. Veuillez lire attentivement les instructions d'installation, d'utilisation et d'entretien avant d'installer ou de réparer ce matériel.

AVERTISSEMENT

Ne pas utiliser cet appareil s'il a été plongé, même partiellement, dans l'eau. Appeler un technicien qualifié pour inspecter l'appareil et remplacer toute partie du système de commande et toute commande qui a été plongée dans l'eau.

AVERTISSEMENT

Pour utilisation
à l'extérieur seulement.

AVERTISSEMENT

Pour utilisation avec naturel ou propane ne gaz seulement Aucun combustibles solides pour être utilisés avec ce système.

DANGER

S'il y a une odeur de gaz:

Coupez l'admission de gaz de l'appareil.

Éteindre toute flamme nue.

Si l'odeur persiste, éloignez-vous de l'appareil et appelez immédiatement

le fournisseur de gaz ou le service d'incendie.

MONOXYDE DE CARBONE

Cet appareil peut produire du monoxyde de carbone, un gaz inodore.

L'utilisation de cet appareil dans des espaces clos peut entraîner la mort.

Ne jamais utiliser cet appareil dans un espace clos comme un véhicule de camping, une tente, une automobile ou une maison.

Table of Contents

3	What's in the BPAWEIS System?
3	Gas Requirements
3	Electrical Requirements
3	Clearance to Combustibles
4	Ventilation
5	BPAWEIS Installation
8	BPAWEIS Completed Diagrams
9	Remote Positioning of the BPAWEIS
9	Operation of the BPAWEIS Burner System
10	Firetronix App Set Up & Management
14	Maintenance of the BPAWEIS Burner System
14	Troubleshooting the Indicator Light
15	Replacement Parts
15	Media Information & Installation
16	Return Policy & Warranty

What's in the BP AWEIS System?

Below is a list of the contents that each Battery Powered AWEIS system contains. If you purchased a different model that includes a type of enclosure, please refer to that specific model number instruction set.

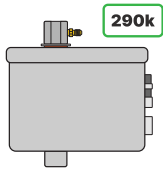

BP AWEIS Ignition Control Module

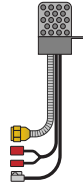

18" Pilot Burner Assembly

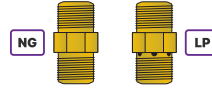

1/2" Orifice or Air Mixer

These are only supplied with our burner systems and are not included.

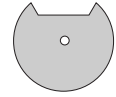

Heat Shield

Options & Additional Items

Our Pilot Burner Assemblies come in a standard 18" length. You can contact us for different lengths in 12", 18", 24", 30" and further with pilot burner extensions.

We also offer Round, Linear and Custom Stainless Steel and Brass Burners. Custom lengths can be ordered as well. All burners come in 1/2" or 3/4" tubing. Contact us to learn more.

Gas Requirements

Fuel Type: Before making gas connections ensure appliance being installed is compatible with the available gas type. *Check the label on the appliance to confirm appliance gas type requirement.*

Gas Pressure: Proper input gas pressures are required for optimum appliance performance.

Pressure	Natural Gas	Propane
Minimum	3.5" W.C. - 1/8 psi	8.0" W.C. - 1/3 psi
Nominal	7.0" W.C. - 1/4 psi	11.0" W.C. - 1/3 psi
Maximum	14.0" W.C. - 1/2 psi	14.0" W.C. - 1/2 psi

Electrical Requirements



Each Battery Powered All Weather Electronic Ignition System is designed to operate on 3 AA batteries.

DO NOT Attempt to Power using 110 Volts AC Power – Damage **WILL RESULT**

Clearance to Combustibles



Please provide adequate clearance to combustible materials as shown below:

Enclosure Clearances

A - Edge of Burner to Enclosure

6"

B - Top of Enclosure to Pan

3"

Clearance to Combustibles

C - Bottom of Valve Box to Combustible Floor

2"

D - Top of Burner to Combustible Ceiling



96" (8ft)

E - Edge of Burner to Combustible Wall

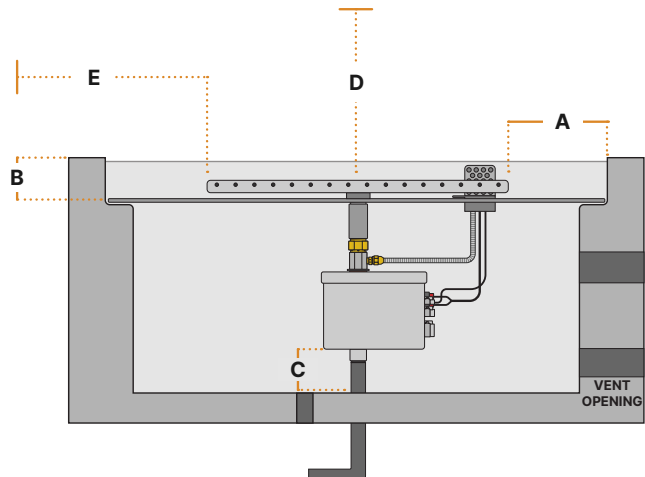
36" (3ft)



Venting the Enclosure for Natural Gas (NG)

NG Natural Gas is lighter than air, therefore any unburned or leaking natural gas will drift up and away from the feature if it has a way out. The illustrations below show how **gas** () will pool towards the top of the burner pan if there is not proper ventilation for the gas to escape. Also shown is the importance of providing an air vent toward the bottom of the feature so that fresh air () can enter the feature to promote even better ventilation for cooling and venting purposes.

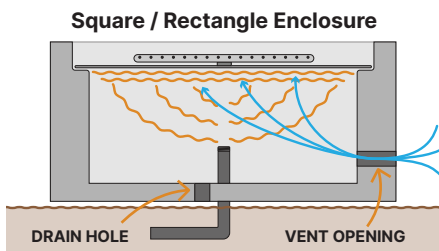
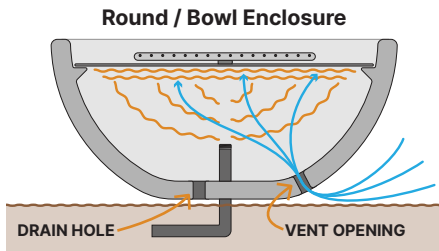

Solutions for Venting with Natural Gas (will not work for Liquid Propane)

Vent Gap – If your enclosure & burner pan support it, you can create a vent “gap” around the perimeter of the burner pan. You achieve this by utilizing a series of Support Tabs that carry the weight of the burner system, leaving a gap throughout most of the perimeter.

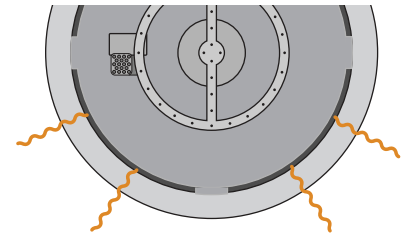

Pan Vent Holes – 1/4” holes can be built into the burner pan in a circular pattern in order to ventilate any gas that accumulates underneath the burner pan.

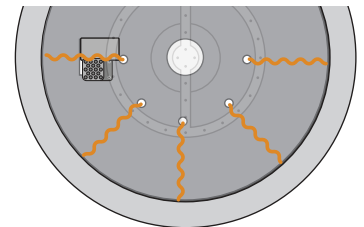

Ask us about how we can provide you a burner pan with proper vent holes!

Venting the Enclosure for Liquid Propane (LP)

LP Liquid Propane is heavier than air, therefore any unburned or leaking gas will drift down and start to pool at the bottom of the enclosure. The illustrations below show how **gas** () will pool towards the bottom of the enclosure if there is not proper ventilation for the gas to escape.

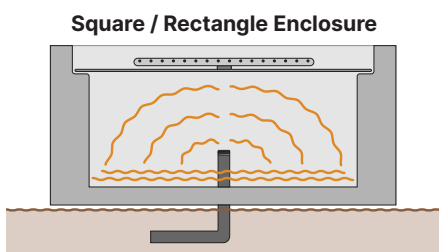
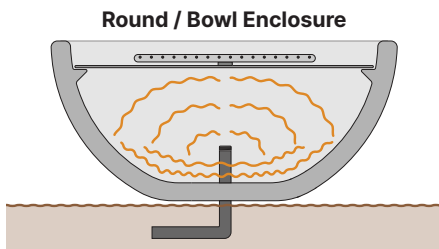

Solutions for Venting with Liquid Propane (will not work for Natural Gas)

Enclosure Vent Holes – By drilling 1/2” holes towards the bottom of the enclosure, you can allow the gas to escape. It is recommended to have 2 vents.

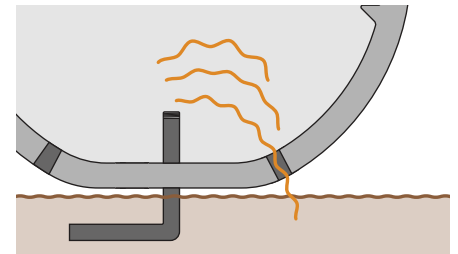

Do not place these vents on the bottom of the enclosure as that will negate the effect.

Spacers – By utilizing the center hole where the gas & conduit lines come in, you can raise your bowl enclosure off the floor by 1/2” therefore allowing plenty of space for gas to escape.

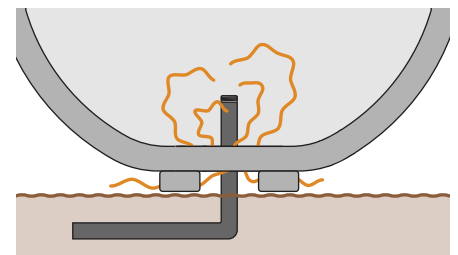

Stainless Steel Mounting Plates are available for elevating bowls off the mounting surface.

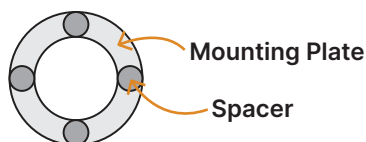

Contact us to learn more.



A fire table or bowl can be placed in a soft area (such as gravel or grass) as long as the feet of the fire table or bowl are placed on a solid surface like a 12” square concrete pad or similar - this ensures the feet do not compress down into soft ground.

AWEIS Installation



STOP: The installation should be done by a **Qualified Service Technician** that is **Locally Licensed**

Step 1 - Preparing the Enclosure

In this set up & instruction set, we will be using a generic non-combustible square enclosure.

Gas & Conduit Placement

When placing your enclosure, you want to ensure that the incoming gas line is in the center of your enclosure, this will ensure that the burner will end up in the center of your enclosure. The incoming conduit is of less importance for placement. See the diagram to the right for an example.



If your enclosure does not provide enough ventilation, you may need to install risers underneath your enclosure to provide proper ventilation. **This is paramount if you are using Liquid Propane.**

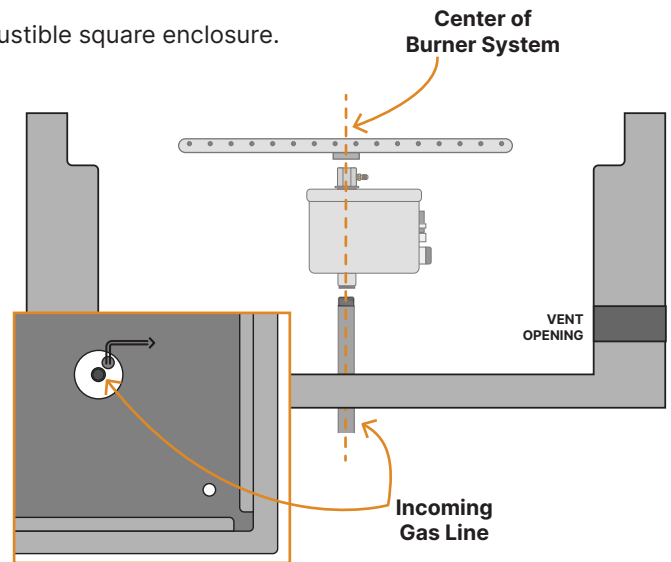

Drainage

Drainage **MUST** be provided in the enclosure. Drainage can be obtained by making holes in the bottom or sides of the enclosure or elevating the enclosure off the mounting surface by way of risers, spacers or similar methods. This is similar to providing proper ventilation.

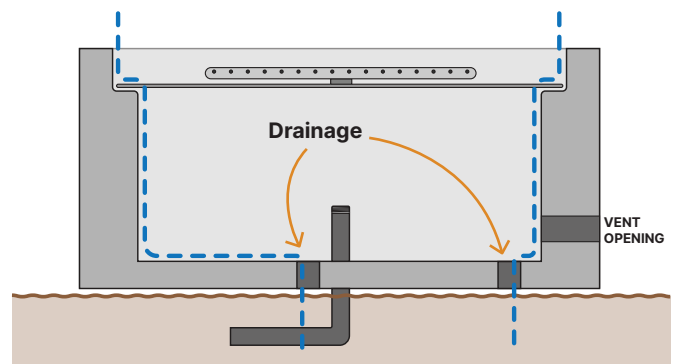

Mounting of Rocker Switch Control Panel

All BPAWEIS come with a Rocker Switch Control Panel. The two options are a 3-position rocker switch for Bluetooth compatible systems and a 2-position rocker switch for On/Off operation only.

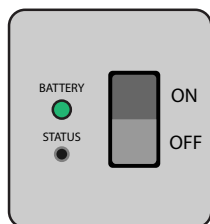

2-Position

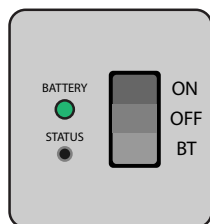

3-Position

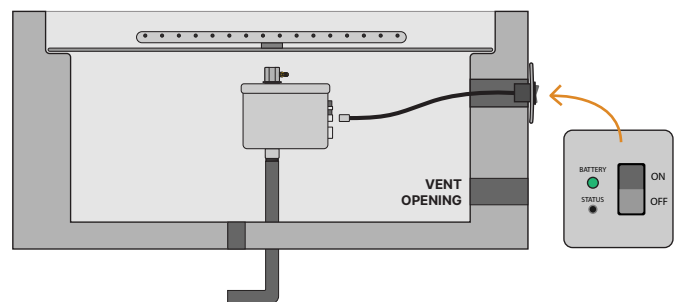

You will need to install the control panel either on the enclosure (shown above) or run the control elsewhere (either to a separate location or perhaps inside a column underneath the enclosure).

Step 2 - Attaching the BP AWEIS Ignition Control Module to the Incoming Gas Line

There are several different methods to connect the BP AWEIS Ignition Control Module to the incoming gas line. **For the remainder of this installation guide, we are going to use the method of attaching the Control Box directly to the Gas Line / Stub.**

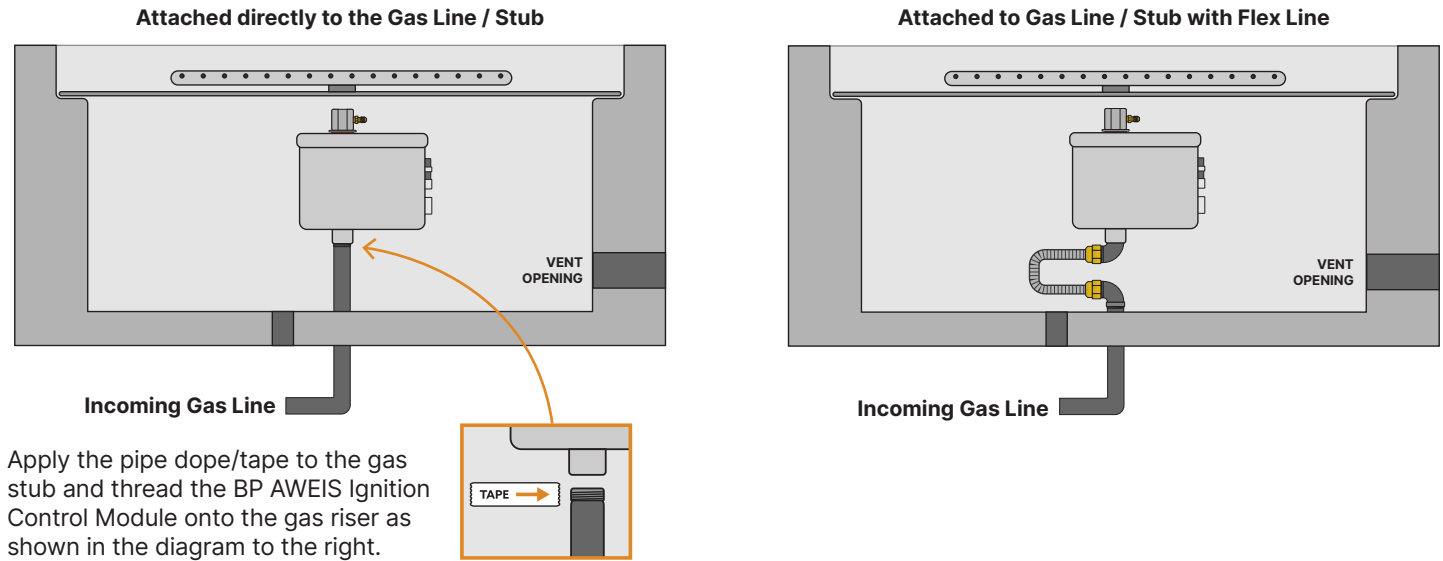

Leak Test – it is highly recommended to perform a gas leak test at this point in the install. Turn on the gas supply and then, using a soapy water solution spray the bottom of the AWEIS where it is connected to the gas line to ensure no leaks exist.

Step 3 - Connecting the BP AWEIS unit to a Power Source

Install 3 AA Batteries (included) into the Waterproof Battery Pack, then insert the moxex connector attached to the wire leading from the Battery Pack into the proper moxex BATTERY terminal on the BPAWEIS Ignition Control Module.

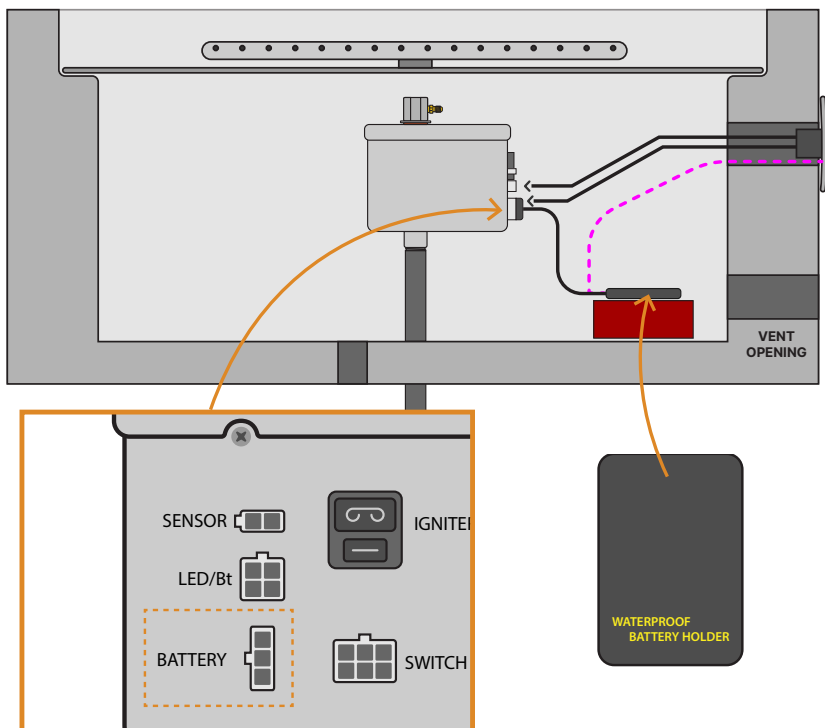

Step 4 - Connecting the AWEIS Pilot Burner Assembly

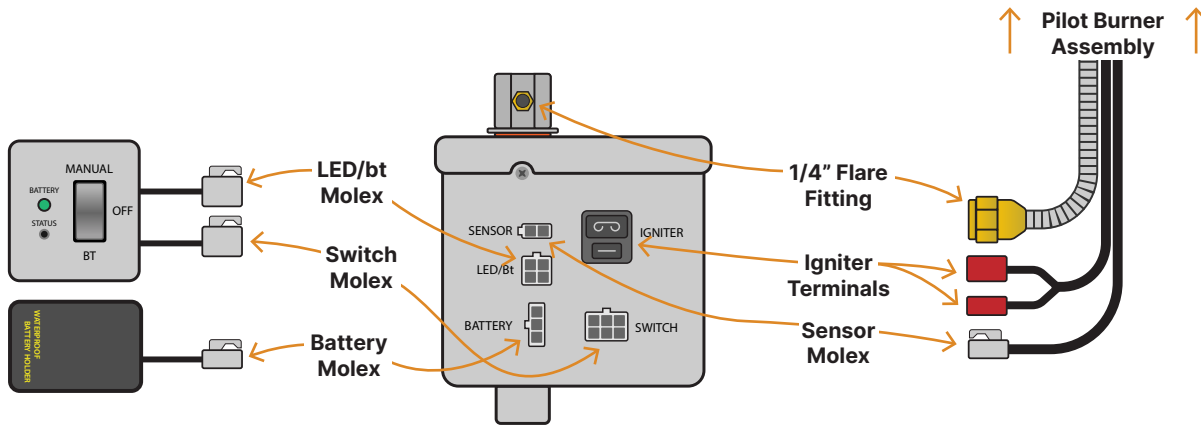

Battery powered models may look completely different from their Hardwired counterpart, but they function the same way. Start with the Switch Molex & the LED/bt Molex. Ensure that the switch is set to OFF before installing the switch. The Battery Molex was already connected in the previous step.

Then start connecting the Pilot Burner Assembly by attaching the Sensor Molex and the Igniter Terminals. One Terminal is Female and the other is Male - please make sure you are connecting the correct terminal - you should not have to apply too much force to connect them.

Finally, thread the 1/4" Flare Fitting on to the top of the BP AWEIS Ignition Control Box. DO NOT apply Teflon Tape or Pipe Dope to this fitting.

Step 5 - Attaching the BP AWEIS Ignition Control Box to the Burner / Pan

In steps 1 - 4 we have been setting up the BP AWEIS itself - now it's time to attach everything to the pan / burner. But, in order to do that we need to talk about the actual connection from the **Control Box to the Burner via the Gas Orifice**. Each BP AWEIS system comes with the proper gas orifice (either Natural Gas or Propane) that was selected at the time of purchase.

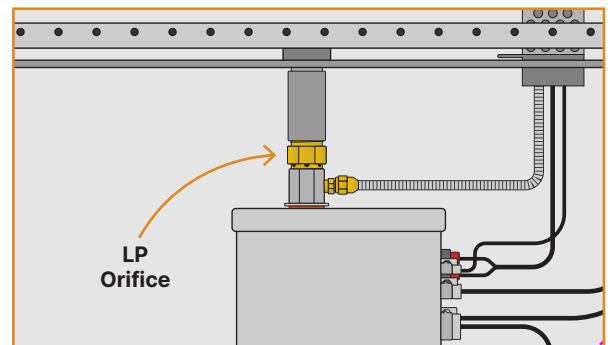
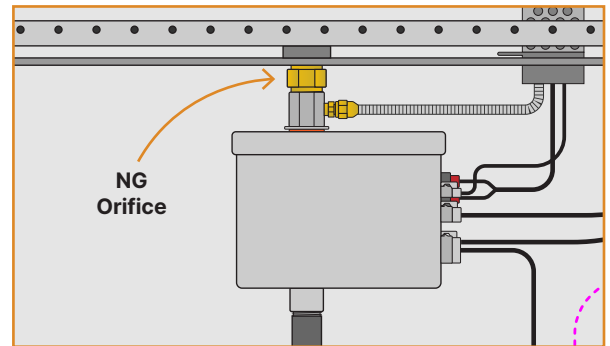
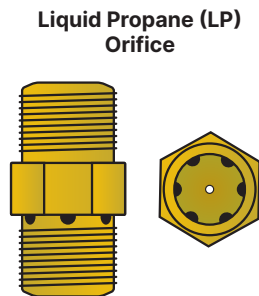

With every fire feature an orifice **MUST** be installed between the outlet of the BP AWEIS Ignition Control Box and the burner.

When the fuel type is Natural Gas a Natural Gas Orifice is to be installed.

When the fuel type is Propane a LP Air Mixer Orifice is to be installed. The noticeable difference between these two orifices are the 6 Air Holes in the LP Air Mixer orifice.

To ensure proper operation of the LP Air Mixer Orifice it must be configured with a coupling and a pipe nipple as shown in far-right photo. The Natural Gas orifice can be installed without a coupling and pipe nipple.

Attaching to the Burner Pan

You will need to line up the Opening for the Pilot Burner with the Pilot Burner.

You will notice that the hole in the center of the pan (for the pipe nipple coming from the Ignition Control Box) and the opening for the Pilot Burner are much larger than needed. This is done to make it easier to Install the Burner Pan. The large gaps around the pipe nipple and Pilot Burner will be covered with additional parts (shown to the right side of the image below).

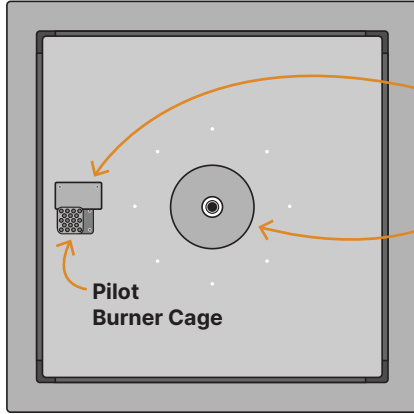
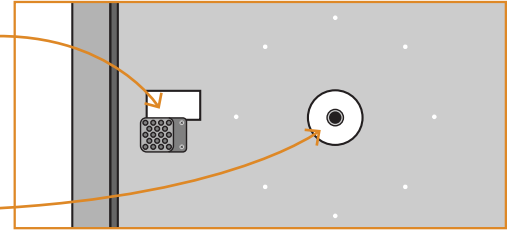

You would have received cover plates (a Rectangle and a Circle - Shown below) along with 4 stainless steel screws (not pictured).

 The rectangle plate is secured to the pan after you have secured the pilot burner to the pan. This prevents media from falling into the enclosure.

 The round plate that covers the excess gap between the pan and the pipe nipple has two smaller holes in it to secure it to the pan using the screws that are provided with the plate. If the pipe nipple is not centered the two smaller holes in the plate may not line up with the matching holes in the pan. It is not required to secure the round plate to the pan but rather recommended. You may have to drill two new holes in the pan to secure the plate to the pan if in fact the holes do not line up.

You can now install the burner



It is recommended to use Teflon Tape or Pipe Dope on the main burner. Position the burner so that the Pilot Burner Cage is within 2 inches of the burner.

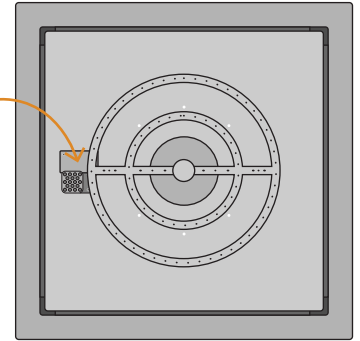
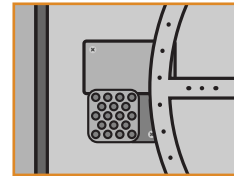

NOTE: Please ensure you install the burner so that the end of the spiral burner is placed up against the pilot burner. This is important to ensure proper operation of the unit.

BP AWEIS Completed Installation Diagrams

The below diagrams are representations of a final & complete installation of a Battery Powered AWEIS system.

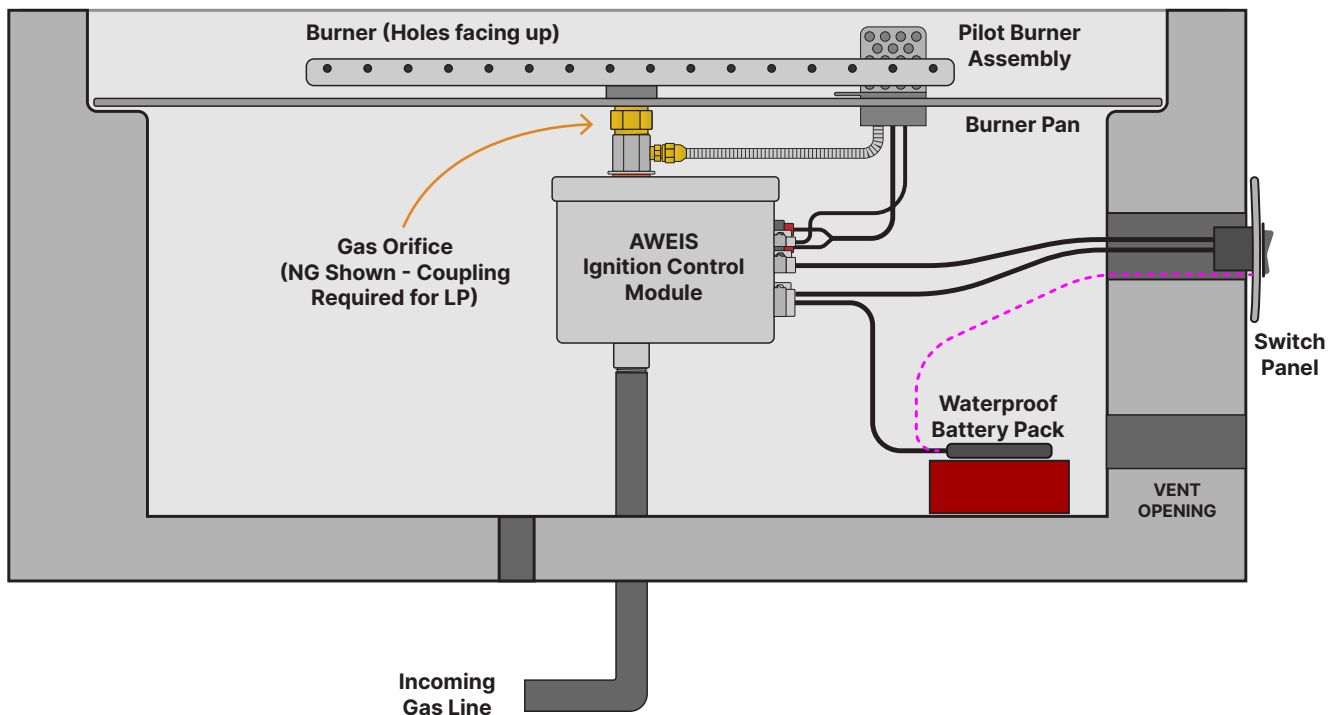

Remote Positioning of the BP AWEIS

The BP AWEIS Box can be only be installed up to **10ft** away from the burner.

This can be beneficial for scenarios where excess heat could compromise the BP AWEIS box.

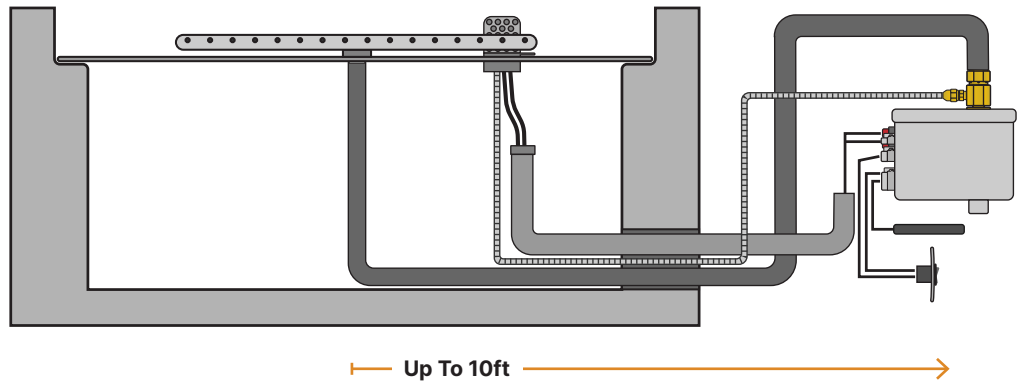

Operation of the BP AWEIS Burner System



Do NOT use this appliance if any part has been under water.

Immediately call a qualified service technician to inspect the appliance and to replace any part of the control system and any gas control which has been under water.



HOT! - DO NOT TOUCH - SEVERE BURNS MAY RESULT - CLOTHING IGNITION MAY RESULT!

Carefully supervise children in same area as appliance. Alert children and adults to hazards of high temperatures. Clothing or other flammable materials should not be hung or placed near the appliance



WARNING! This appliance should be inspected before use and at least annually by a **Qualified Service Technician that is Locally Licensed.**

Any guard or protective device removed for servicing must be replaced prior to operation. Keep the appliance area clear and free from combustible materials, gasoline and other flammable vapors and liquids.

Prior to turning appliance on, visually inspect the fire feature to ensure debris such as leaves or other combustible material has not collected inside the feature which could burn and emit embers once the fire feature is turned on. Also ensure any person standing close to the fire feature is aware you will be turning the fire feature on prior to actually turning it on.

Turn the fire feature on by flipping the ON/OFF Switch to the ON position.

Below is the Sequence of Operation for Battery Powered Models:

- Switch ON: LED light begins flashing green indicating ignition is about to begin.
- Gas Valve opens and spark ignition begins.
- Ignition occurs almost immediately (assuming gas is present).

NOTE: When the system is put into MANUAL mode, there is an automatic 2-hour timer that will automatically shut off the unit. This is an intended safety feature.

Fire Feature Shut Down for Battery Powered Models:

- Flip the ON/OFF Switch to the OFF position.



WARNING! If fire feature fails to turn off completely (small flames still visible) - Turn off gas supply using the manual gas shut-off.



FIRETRONIX SET UP & MANAGEMENT

Adding a New Fire Feature & Setting the Password

Find the Firetronix APP on your Home Screen and launch the app.

You will be presented with the “Find Devices” screen.

On the faceplate of your BPAWEIS Switch Panel there is a 3 position rocker switch. Move the rocker to the position marked BT. Once you do, the Battery Status LED will start blinking Blue. This lets you know that your device is discoverable.

Tap “Find Devices” to search for your fire feature. Once found, press the “Pair” button to pair your phone to the BPAWEIS.



BPAWEIS Switch Panel

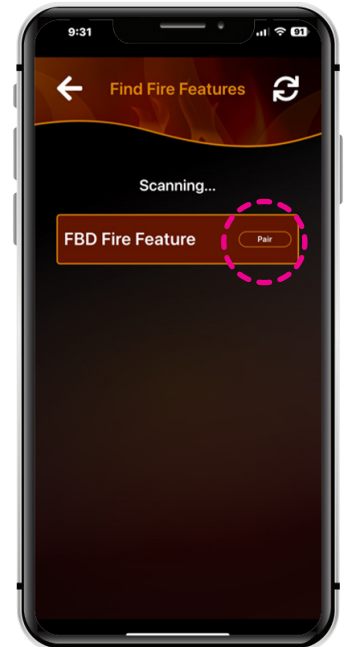
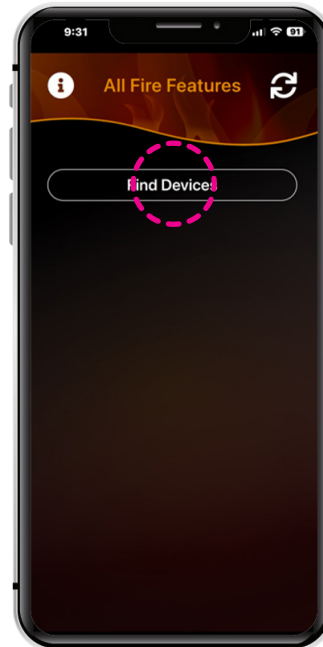
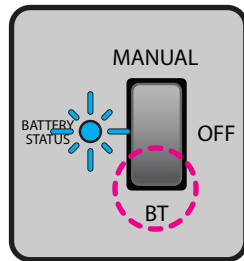

Once the Fire Feature is found, you will be presented with the Fire Feature Name and the Password.

A default name is already present in the Name field. At this point you can edit the Name of your Fire Feature. Make it something recognizable to you.



A password has also been preloaded into the password field.

You do not have to set a new password, but the app forces you to go through the password changing process for initial set up - so you might as well choose a password that will be easier to remember.

Let's change your password to something that will be easier to remember.

 **HOW THE APP USES PASSWORDS**

The password that you set up is stored on the BP AWEIS itself. The intended use of this password is if you want to share this fire feature with another phone. That phone will need to use the same password to access and control the fire feature.

Once you set the password, you will not have to enter the password again on your device.

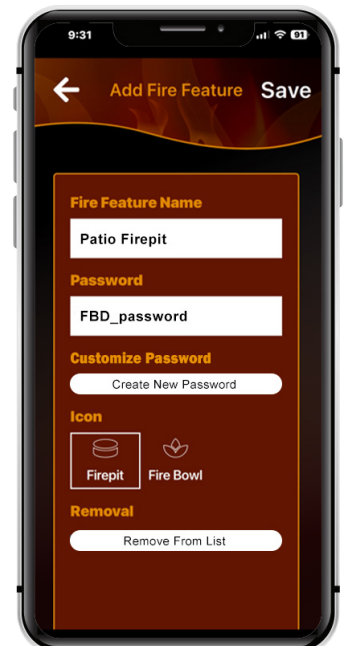

Tap “Create New Password” and you will be taken to the “Set Password” page.

Type your desired password into the two fields and tap “Save Password”. You will get a dialog box that says your password was saved successfully. Press the X in the top right hand corner of the dialog box. Your new password has been saved.



Tap “Create New Password”



Enter the same password in both fields and tap “Set Password”



Tap the X when finished



See your new password displayed in the Password field.

After setting your password, you will be back at the Add Fire Feature screen with your new password shown in the password field.

You can also choose from a Firepit Icon or a Fire Bowl Icon.

Once you have made your selections, press Save in the top-right hand corner of the screen.

You should then be presented with the screen shown below that will show your new fire feature with your new name.

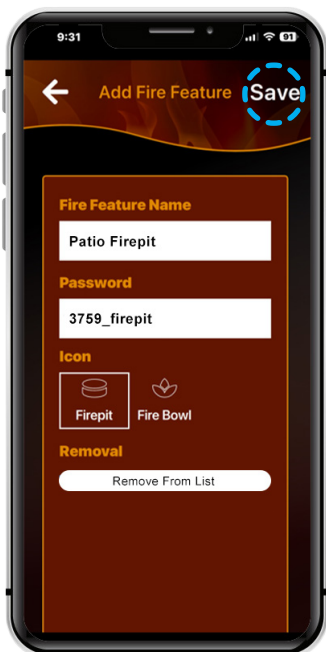

You can choose your Icon and then tap “Save”



Your Fire Feature has been successfully added

NOTE: If you decide not to change the preloaded password (by tapping SKIP on the “set password” page), your Fire Feature will display an “unlocked” warning icon in the top left-hand corner of the fire feature display area.

It’s important to set a custom password because it not only helps you remember the password, but it is far more secure than a default password.

Once you set a custom password, the icon will go away.

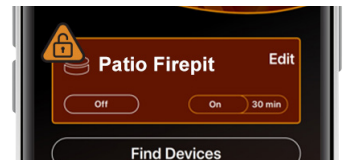

NOTE: You will not have to enter your password again on this device, but if you need to set up another phone to control the fire feature and you forget or cannot access the current set password, you will receive this dialog box when setting up the app.

Please see the section called “Resetting Your Password” in this instruction set.

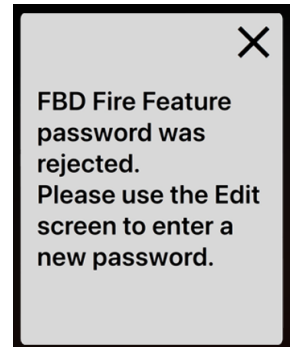

Using the Firetronix App to Control Your Fire Feature

To turn on your fire feature: Press the “On” button located on the right side of the fire feature display area.

The fire feature display area will illuminate red, and the Switch Panel on the fire feature will blink green 3 times indicating ignition has started.

You will also see the Auto-Shutoff timer countdown start and be displayed at the top of the fire feature area (see Managing the Auto-Shutoff section of this instruction set).

To turn OFF your fire feature: Press the “Off” button located on the lower left side of the fire feature display area. Once pressed, the fire feature area will no longer be illuminated and the auto-shutoff timer will disappear.



Tap the “On” button

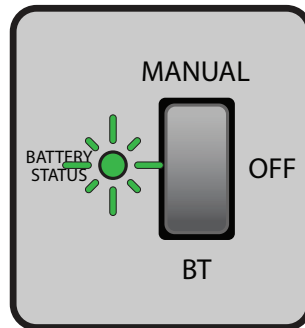

Blink Green 3 Times

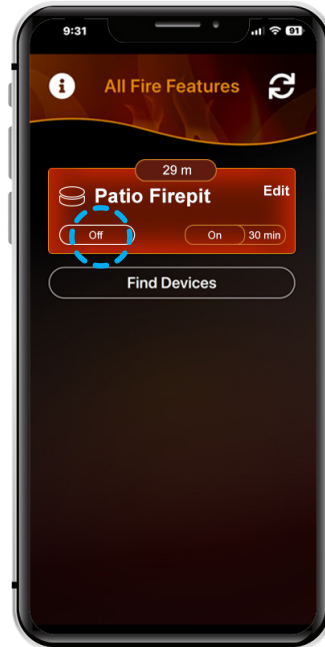

Tap the “Off” button

Managing the Auto-Shutoff

Anytime you turn on your fire feature using the app, there is an auto-shutoff timer associated with it.

You cannot turn on the fire feature without an auto-shutoff time - it is required and forced by the app.

In order to change that Auto-Shutoff timer, tap the displayed time to the right of the “On” button. This will pop up with a dialog box with the following auto-shutoff options:

- 30 minutes
- 1 Hour
- 2 hours
- 3 hours
- 4 hours

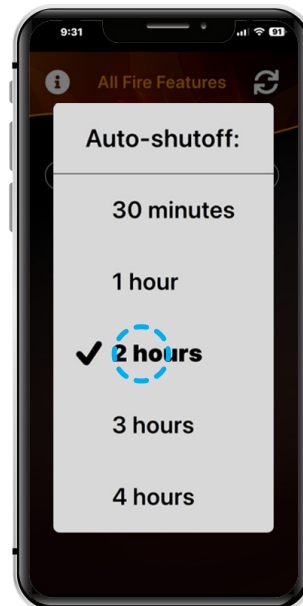
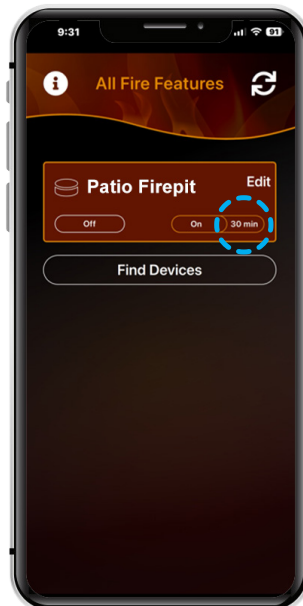

Tap your desired shutoff timer duration and the dialog box will close, and your selected shutoff time duration will be displayed next to the “On” button.

NOTE: When the timer has “1 minute” remaining the Switch Panel LED will blink yellow (indicating that the Fire Feature is about to shut off), and the timer will disappear and shortly after that the feature will automatically shut off.

Re-Ignition Shortly After Turning Off

If you try to turn the feature on shortly after turning it off you will see a message pop up saying “FBD Fire Feature in cool down state to clear gas”.

There will also be a yellow triangle “caution” Icon that appears.

If you try to turn the feature on when you see the yellow caution icon the LED indicator light will blink yellow. Wait approximately 30 seconds or until you see the caution icon disappear.



Resetting Your Password

In order to reset your password, you will need to reset the BP AWEIS itself and remove the Fire Feature from the app in order to go through the initial start up sequence.

Start by going to your app, selecting “Edit” on the Fire Feature Display Area, then tapping the “Remove From List” button.

This means that the Fire Feature has been removed from the app. You are now ready to start the BP AWEIS Reset process.

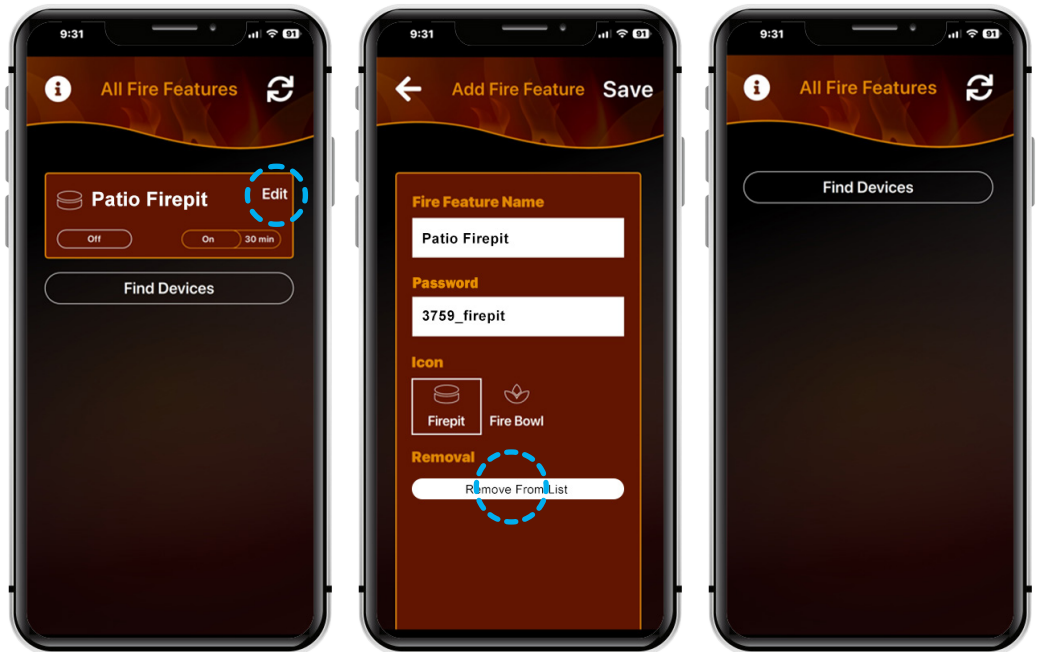

There is a small hole located on the BP AWEIS box, on the side with all the connectors, in the corner. That is the reset button. You will need to use a tool that fits into the hole to hold the reset button. Follow this sequence to reset the BP AWEIS:

Step 1: Set the rocker switch on the Switch Panel to the “OFF” position (middle).

Step 2: Press and hold the reset button on the BP AWEIS.

Step 3: While holding the reset button, set the rocker switch to the BT position.

Step 4: Once the LED light flashes Blue & Purple, you can let go of the Reset Button.

Your device is now discoverable and you go through the set up process and reset the password (See Adding a New Fire Feature & Setting the Password section of this instruction manual).

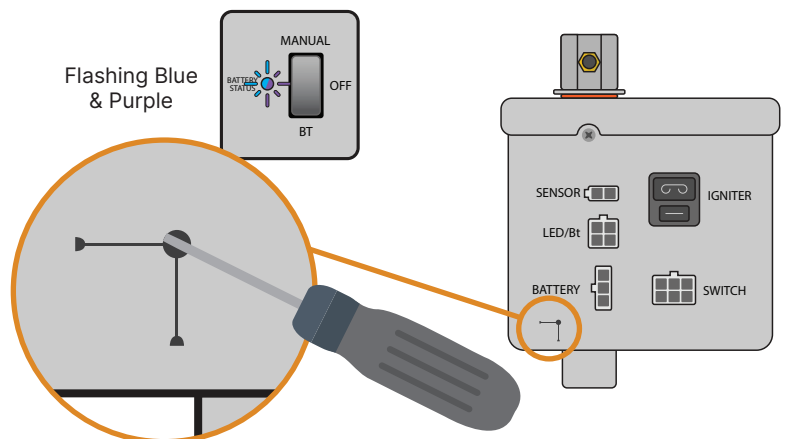

Maintenance of the BP AWEIS Burner System



WARNING!

Maintenance should be done by a **Qualified Service Technician**. The appliance should be inspected before use and at least annually.

Ensure gas & power are shut off and the appliance is cool before servicing. Any guard or protective device removed for servicing must be replaced prior to operation.

Prior to Each Use:

- Inspect for debris in the Fire Feature & inside the enclosure. Remove any debris prior to use.

Semi-Annually:

- Visually inspect Pilot Burner for debris / insect infestation (spider webs).
- Visually inspect burner holes for debris / insect infestation.
- Clean either of the above if necessary using compressed air.

Annually:

- Visually inspect Pilot Burner for excess corrosion due to heat and moisture.
- Turn fire feature on to ensure proper operation.

LED Status Indicator Troubleshooting

The LED light incorporated in the ON/OFF Switch is programmed to indicate failure modes within the Battery Powered AWEIS System. Assuming there is a good gas source supplying gas to the feature the system should operate normally. If it does not the indications from the LED will help troubleshoot the problem. Below is a table showing the different LED Light Flash Sequences programmed into the system. Use this table to diagnose what is going on with the system.

LED Flash Sequence	Indication
	Battery is good. Fire is igniting / re-igniting
	Battery is low but usable, replace soon. Fire is igniting.
	Battery is too low to allow operation. Replace batteries.
	Battery is critically low, turn off immediately and replace batteries.
	Successful ignition; entry into Main Fire. Feature is now over 99% electrically self-powered.
	Ignition has failed. Will attempt re-ignition shortly. Recommend leaving on after seeing this light sequence if last fire was shutoff by the user during gas clearing delay - this will occur at startup. After a brief delay, fire will start normally.
	Ignition has failed and no re-ignition attempts remain. Cycle ON/OFF switch to restart.
	Controller Fault Detected. Turn Power Off - wait 30 seconds and then turn back ON to clear fault. If the flashing Blue continues to flash controller must be replaced.

Replacement Parts for the Battery Powered AWEIS Burner System

Identifier	Part #	Description
A	BPBA	Pilot Burner Assembly
B	BPack	Battery Pack Assembly
C	BRS	Rocker Switch Assembly
D	LED	LED Light Assembly
E	BICB	Ignition Control Module

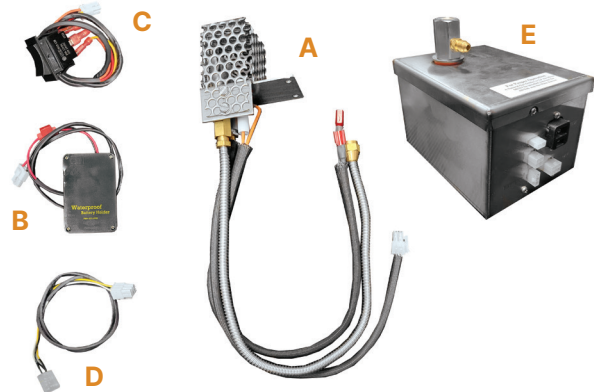

Media Information & Installation



WARNING! Do not use any other material as filler/topping media inside fire features other than those listed below. Using improper media inside a fire feature could result in damage to property or injury to persons nearby due to media “popping” or “exploding” due to heat.

List of Acceptable Media:

- Lava Rock (or other Igneous Rock) - No larger than 2” in diameter.
- Fireglass approved for use in fire features.
- Man-made Stone for use in fire features (Refractory Material).

MEDIA INSTALLATION NOTE

The use of media inside fire features is recommended due to the fact it enhances the look of the fire feature but also improves its performance by forcing the gas emanating from the burner to mix as it passes through the media. This ‘mixing’ of gases creates an even flame throughout the feature and helps spread the flame from the Pilot Burner throughout the burner quicker than when there is no media.

Recommended thickness of the media above the burner element is NO MORE than 2”. Due to the fact the Pilot Burner must be partially exposed to oxygen in order to ignite the pilot flame during startup **DO NOT COMPLETELY COVER THE PILOT BURNER.**

When installation of the media is complete the top of the Pilot Burner Protective Cover should be visible.



NOTE | MEDIA MUST BE PRESENT!

Media (ie: Lava Rock or Fireglass) must **at least** be present in and around the pilot burner. If no media is present, the system may repeatedly cycle on and off. The media acts as a windbreak for the system.

Lava Rock Installation

The size lava rock in this visual example is 2” in diameter.

The picture on the far right is a close up of the Pilot Burner. Notice it is barely visible in either of the photos.

When using smaller lava rock you may not be able to cover it as well due to the fact the smaller rock may “smother” the Pilot Burner and prevent oxygen from getting to it.

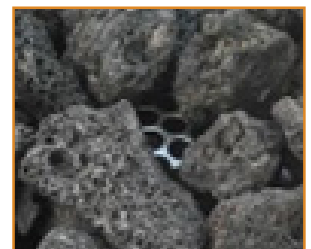

Fireglass Installation

The size fireglass used in visual example is 1/2” in diameter.

The picture on the far right is a close up of the Pilot Burner. Notice it is barely visible in either of the photos.

When using smaller fireglass you may not be able to cover it as well due to the fact the smaller rock may “smother” the Pilot Burner and prevent oxygen from getting to it.

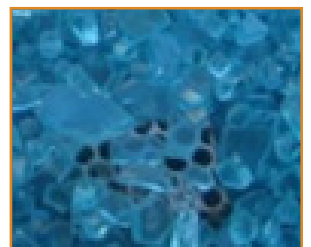

Return Policy

All orders from Fire by Design (FBD) may be returned within 30 days for a full refund. In order to return or exchange (under the warranty guidelines described in the **Fire by Design Limited Warranty** section of this instruction set) all or part of your order, you must contact us for a Return Merchandise Authorization number (RMA#). Call toll free (877) 807-8923 to obtain an RMA# from a FBD representative.

All returned merchandise must be in the original packaging including manuals, accessories, cables, etc. with the authorization (RMA#) clearly printed on the outside of the package. Return requests must be made within 30 days of the receipt date. Any shipping and/or handling charges on the original order cannot be refunded. At our discretion, we may levee a restocking fee of 15% of the cost of items returned.

FBD is not responsible for shipping costs or damage on returned items. Units to be returned should be packed carefully. Please be advised that packages sent by normal US Postal Service cannot be tracked to ensure delivery.

Since FBD cannot provide credit for a return without confirming its receipt, we recommend that you use a delivery service that can be tracked and or insured.

Fire by Design | Limited Warranty

Fire by Design warrants its products to be free from defective material and workmanship for the period of time indicated below for each product line. The warranty time periods listed below are from the original date of purchase. Fire by Design agrees to repair or replace, at its sole discretion, a defective product if returned to Fire by Design within the warranty period and accompanied by proof of purchase. This warranty does not extend to any Fire by Design products which have been subject to misuse, neglect, accident, incorrect wiring or to use in violation of operating instructions furnished by us, nor extend to any units altered or repaired for warranty defect by anyone other than Fire by Design. This warranty does not cover any incidental or consequential damages and is in lieu of all other warranties expressed or implied and no representative or person is authorized to assume for us any other liability in connection with the sale of our products. Some states do not allow limitations on how long an implied warranty lasts, and/or the exclusion or limitation of incidental or consequential damages so the above limitations and exclusions may not apply to the original CUSTOMER. This warranty gives you specific rights and you may also have other rights, which vary, from state to state. If you have any questions concerning this warranty call (877) 807-8923.

Bowls

All Decorative GFRC, Stainless, Copper or Aluminum Bowls are warranted for (2) years from delivery date against any manufacturing defect or structural failure. Small stress cracks and surface crazing are a natural occurrence in concrete and not covered by warranty.

Fire Rings

All 304 Stainless Steel Rings are warranted for (3) years. 316 Stainless Steel Burners (Marine Grade) have a Lifetime Warranty.

Burner Pans

All 304 Stainless Steel Burner Pans warranted for (5) years. All Aluminum Burner Pans have a Lifetime Warranty.

Electronic Ignition Systems (Field Serviceable AWEIS SC, HC, XHC, SUBEIS, BP AWEIS)

All Field Serviceable AWEIS and SUBEIS systems are warranted for (1) year from date of purchase for Commercial Applications and (3) years from date of purchase for Residential Applications provided the product has not been modified, abused, misused or improperly installed, maintained or repaired during such period. Fire by Design, at its discretion, will either repair or replace the defective product. If one of the Field Serviceable parts of an AWEIS or SUBEIS fails a replacement part will be provided at no charge to the customer. Labor cost to replace the failed field serviceable is not covered under this warranty. If a part other than a Field Serviceable part fails that part will be replaced or repaired at no charge to the customer.

Vulcan Fire Module & Tiki Torches

Vulcan Fire Modules and Automated Tiki Torches are warranted for (1) year from the date of purchase.

The original purchasing information such as an invoice or product serial number is required on all warranty returns.