



# AWEIS Ignition System

## ALL WEATHER ELECTRONIC IGNITION SYSTEM > INSTRUCTIONS

### Models Covered in this Instruction Set



290k

#### Standard Capacity Models

- > SCGNG-FS  
290k BTU | 24VAC | Natural Gas
- > SCGLP-FS  
290k BTU | 24VAC | Liquid Propane
- > SCGNG30-FS  
290k BTU | 30VDC | Natural Gas
- > SCGLP30-FS  
290k BTU | 30VDC | Liquid Propane
- > SCGNG120-FS  
290k BTU | 120VAC | Natural Gas
- > SCGLP120-FS  
290k BTU | 120VAC | Liquid Propane



780k

#### High Capacity Models

- > HCGNG-FS  
780k BTU | 24VAC | Natural Gas
- > HCGLP-FS  
780k BTU | 24VAC | Liquid Propane
- > HCGNG30-FS  
780k BTU | 30VDC | Natural Gas
- > HCGLP30-FS  
780k BTU | 30VDC | Liquid Propane
- > HCGNG120-FS  
780k BTU | 120VAC | Natural Gas
- > HCGLP120-FS  
780k BTU | 120VAC | Liquid Propane

### Product Certifications

This QR Code will always take you to the most recent certifications for the entire Fire by Design product line.

You can also type in the URL directly: <http://fbdqr.com/product-certs>



**WARNING:** For Outdoor Use Only



**STOP:** If you cannot read or understand these instructions, do **NOT** attempt to install or operate this appliance.



**STOP:**

#### IF YOU SMELL GAS

- Shut off gas to the appliance
- Extinguish any open flame
- If odor continues, keep away from the appliance and immediately call your gas supplier or fire department

**INSTALLER:** Leave this manual with the appliance.  
**CONSUMER:** Retain this manual for future reference.

### Proposition 65 Warning

Operating, servicing and maintaining this appliance can expose you to chemicals including

Carbon Monoxide and Lead which are known to the State of California to cause cancer, birth defects or other reproductive harm. For more information go to [www.Prop65Warnings.ca.gov](http://www.Prop65Warnings.ca.gov)



**WARNING**

Improper installation, adjustment, alteration, service or maintenance can cause injury or property damage. Read the installation, operating and maintenance instructions thoroughly before installing or servicing this equipment



**WARNING**

For use with NATURAL or LP GAS Only  
**NO SOLID FUELS TO BE USED WITH THIS SYSTEM**

**WARNING**

Do not store or use gasoline or other flammable vapors and liquids in vicinity of this or any other appliance.  
An LP-cylinder not connected for use shall not be stored in the vicinity of this or any other appliance.

**CARBON MONOXIDE HAZARD**

This appliance can produce carbon monoxide which has no odor.  
Using it in an enclosed space can kill you.  
Never use this appliance in an enclosed space such as a camper, tent, car or home.

Installation must conform with local codes or, in the absence of local codes, with the National Fuel Gas Code, ANSI Z223.1 / NFPA 54, or International Fuel Gas Code.

The appliance, when installed, must be electrically grounded in accordance with local codes or, in the absence of local codes, with the National Electric Code, ANSI/NFPA 70, if applicable.



**AVERTISSEMENT**

Ne pas entreposer ni utiliser de l'essence ni d'autres vapeurs ou liquides inflammables dans le voisinage de l'appareil, ni de tout autre appareil.  
Une bouteille de propane qui n'est pas raccordée en vue de son utilisation, ne doit pas être entreposée dans le voisinage de cet appareil ou de tout autre appareil.



**AVERTISSEMENT**

Une installation, un ajustement, une modification, une réparation ou un entretien inapproprié peuvent être la cause de blessures ou de dommages. Veuillez lire attentivement les instructions d'installation, d'utilisation et d'entretien avant d'installer ou de réparer ce matériel.

**AVERTISSEMENT**

Ne pas utiliser cet appareil s'il a été plongé, même partiellement, dans l'eau. Appeler un technicien qualifié pour inspecter l'appareil et remplacer toute partie du système de commande et toute commande qui a été plongée dans l'eau.

**AVERTISSEMENT**

Pour utilisation à l'extérieur seulement.

**AVERTISSEMENT**

Pour utilisation avec naturel ou propane ne gaz seulement Aucun combustibles solides pour être utilisés avec ce système.

**DANGER**

S'il y a une odeur de gaz:  
Coupez l'admission de gaz de l'appareil.  
Éteindre toute flamme nue.  
Si l'odeur persiste, éloignez-vous de l'appareil et appelez le fournisseur de gaz ou le service d'incendie.

**MONOXYDE DE CARBONE**

Cet appareil peut produire dumonoxyde de carbone, un gaz inodore.  
L'utililisation de cet appareil dans des espases clos peut entrainer la mort.  
Ne jamais utiliser cet appareil dans un espace clos comme un vehicule de damping, une tente, une automobile ou une maison.

## Table of Contents

---

4	What's in the AWEIS System?
4	Gas Requirements
4	Electrical Requirements
5	Daisy Chain Wiring
5	Clearance to Combustibles
6	Ventilation
7	AWEIS Installation
10	Remote Positioning of the AWEIS
11	AWEIS Completed Diagrams
12	Operation of the AWEIS Burner System
12	Maintenance of the AWEIS Burner System
13	Troubleshooting the AWEIS Burner System
13	Replacement Parts
14	Automated Pool Control Wiring
15	Media Information & Installation
17	Return Policy & Warranty

## Icon Legend

---

**24VAC** 24VAC - Hardwired 24VAC Models

**30VDC** 30VDC - Hardwired 30VDC Models

**120VAC** 120VAC - Plug-In 120VAC Models

**290k** Standard Capacity - 290k BTU Models





**780k** High Capacity - 780k BTU Models

**NG** Natural Gas Models

**LP** Liquid Propane Models

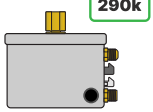
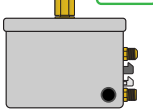
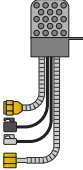
## What's in the AWEIS System?

Below is a list of the possible contents that each AWEIS system contains. If you purchased a different model that includes a type of enclosure, please refer to that specific model number instruction set.

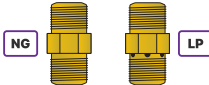
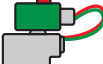
 <p><b>A</b></p> <p>1/2" AWEIS Box - FS</p>	 <p><b>B</b></p> <p>3/4" AWEIS Box - FS</p>	 <p><b>C</b></p> <p>18" Pilot Burner Assembly</p>	 <p><b>D</b></p> <p>50VA 24VAC Transformer</p>
 <p><b>E</b></p> <p>185VA 30VDC Power Supply</p>	 <p><b>F</b></p> <p>120VAC Adapter</p>	 <p><b>G</b></p> <p>1/2" Orifice or Air Mixer</p> <p>These are only supplied with our burner systems and are not included.</p>	 <p><b>H</b></p> <p>Safety Back Up valve Liquid Propane Only</p>

### Standard Capacity Models 290k

The Standard Capacity AWEIS models come standard with the following items:

**A** + **C** + **H** (H = Liquid Propane Only)

If you have a 24VAC model, you will also receive: **D**

If you have a 30VDC model, you will also receive: **E**

If you have a 120VAC model, you will also receive: **F**

### Options & Additional Items

Our Pilot Burner Assemblies come in a standard 18" length. You can contact us for different lengths in 12", 18", 24", 30", and further with pilot burner extensions.

We also offer Round, Linear and Custom Stainless Steel and Brass Burners. Custom lengths can be ordered as well. All burners come in 1/2" or 3/4" tubing. Contact us to learn more.

All LP units come with a standard build of a Safety Backup Valve Included.

## Gas Requirements

**Fuel Type:** Before making gas connections ensure appliance being installed is compatible with the available gas type. *Check the label on the appliance to confirm appliance gas type requirement.*

**Gas Pressure:** Proper input gas pressures are required for optimum appliance performance.

Pressure	Natural Gas	Propane
Minimum	3.5" W.C. - 1/8 psi	8.0" W.C. - 1/3 psi
Nominal	7.0" W.C. - 1/4 psi	11.0" W.C. - 1/3 psi
Maximum	14.0" W.C. - 1/2 psi	14.0" W.C. - 1/2 psi

## Electrical Requirements

 Each All Weather Electronic Ignition System is designed to operate on specific power source that is hardwired to either a 24 Volt AC transformer or a 30 Volt DC power supply or 120 Volt AC Adapter. *(Check labeling on your specific AWEIS to verify the required voltage and power supply).*

**DO NOT** Attempt to power 24 Volt AC or 30 Volt DC systems with 120 Volts AC Power – Damage **WILL RESULT**

**Recommended Wire Size:** 12-gauge wire for all hardwired installations.

## Daisy Chain Wiring of Multiple AWEIS

The Fire by Design 24 Volt AC AWEIS has a **Blue** and a **Yellow** wire protruding from it, while 30 Volt DC versions have a **Black** and a **Red** wire. These are the power wires.

When daisy chaining multiple AWEIS, the polarity between the AWEIS **MUST** be the same.

To achieve this, all the **Blue** or **Black** wires must be connected to the same wire from the power supply and all the **Yellow** or **Red** wires connected to the other wire from the power supply as shown in this illustration.

### 24VAC 24VAC Transformer + Multiple AWEIS

**NOTE** – Each ignition system requires 50 voltage amps in order to deliver proper power. Please contact us for more information.

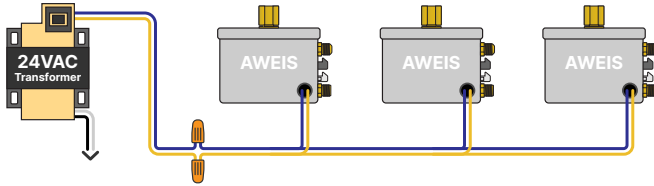

According to Fire by Design specifications & warranty, a maximum of 3 AWEIS can be daisy chained together.

**Do not daisy chain more than 3 AWEIS.**

### 30VDC 30VDC Power Supply + Multiple AWEIS

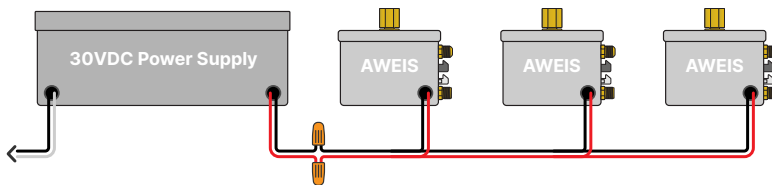

### 120VAC 120VAC + Multiple AWEIS

The 120VAC adapter can only power (1) AWEIS so daisy chaining multiple AWEIS is not possible with the adapter.

## Clearance to Combustibles



Please provide adequate clearance to combustible materials as shown below:

### Enclosure Clearances

**A** - Edge of Burner to Enclosure

6"

**B** - Top of Enclosure to Pan

3"

### Clearance to Combustibles

**C** - Bottom of Valve Box to Combustible Floor

2"

**D** - Top of Burner to Combustible Ceiling



96" (8ft)

**E** - Edge of Burner to Combustible Wall

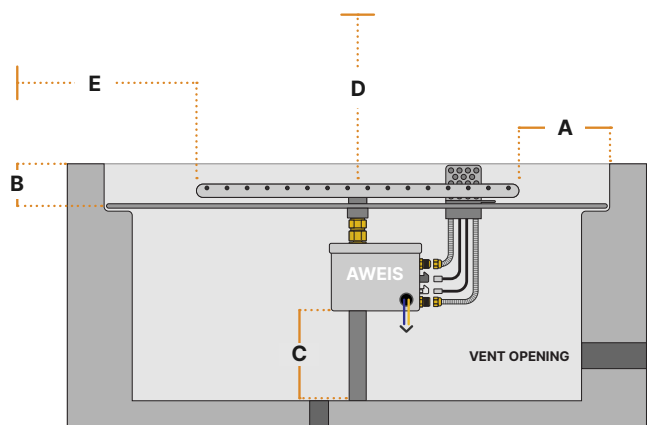
36" (3ft)



## Venting the Enclosure for Natural Gas (NG)

**NG** Natural Gas is lighter than air, therefore any unburned or leaking natural gas will drift up and away from the feature if it has a way out. The illustrations below show how **gas** (  ) will pool towards the top of the burner pan if there is not proper ventilation for the gas to escape. Also shown is the importance of providing an air vent toward the bottom of the feature so that fresh air (  ) can enter the feature to promote even better ventilation for cooling and venting purposes.

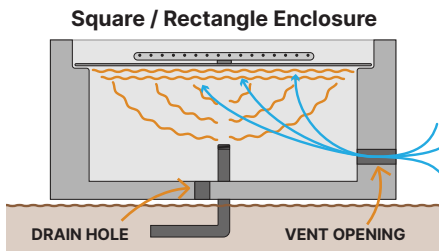
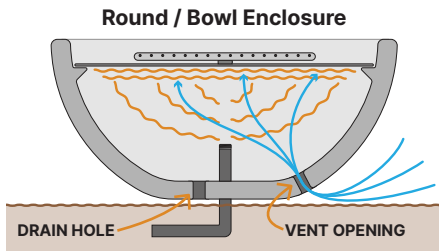

### Solutions for Venting with Natural Gas (will not work for Liquid Propane)

**Vent Gap** – If your enclosure & burner pan support it, you can create a vent “gap” around the perimeter of the burner pan. You achieve this by utilizing a series of Support Tabs that carry the weight of the burner system, leaving a gap throughout most of the perimeter.

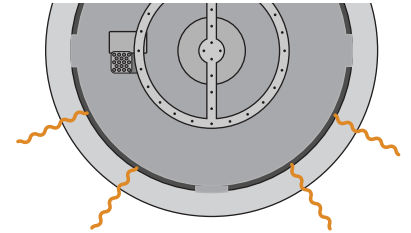

**Pan Vent Holes** – 1/4” holes can be built into the burner pan in a circular pattern in order to ventilate any gas that accumulates underneath the burner pan.

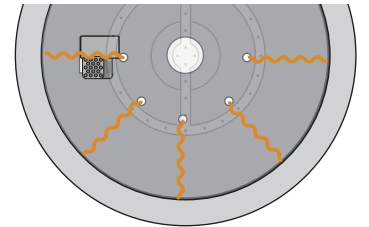

**Ask us about how we can provide you a burner pan with proper vent holes!**

## Venting the Enclosure for Liquid Propane (LP)

**LP** Liquid Propane is heavier than air, therefore any unburned or leaking gas will drift down and start to pool at the bottom of the enclosure. The illustrations below show how **gas** (  ) will pool towards the bottom of the enclosure if there is not proper ventilation for the gas to escape.

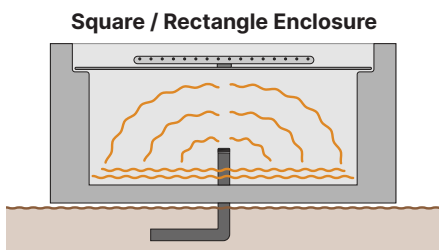
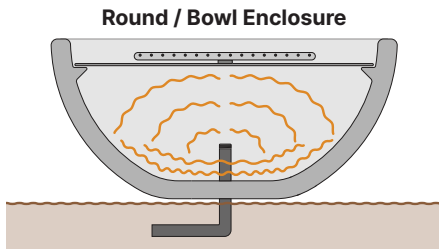

### Solutions for Venting with Liquid Propane (will not work for Natural Gas)

**Enclosure Vent Holes** – By drilling 1/2” holes towards the bottom of the enclosure, you can allow the gas to escape. It is recommended to have 2 vents.

**Do not place these vents on the bottom of the enclosure as that will negate the effect.**

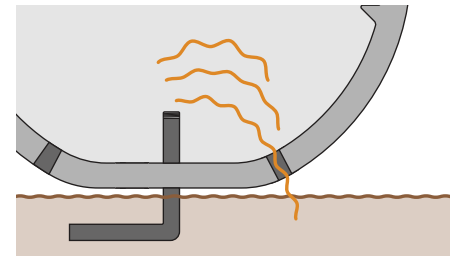

**Spacers** – By utilizing the center hole where the gas & conduit lines come in, you can raise your bowl enclosure off the floor by 1/2” therefore allowing plenty of space for gas to escape.

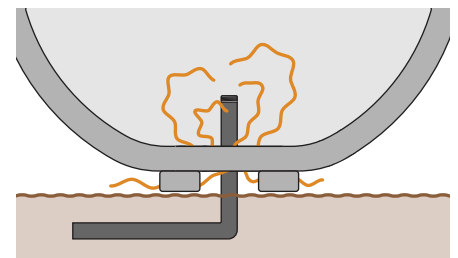

**Stainless Steel Mounting Plates** are available for elevating bowls off the mounting surface.

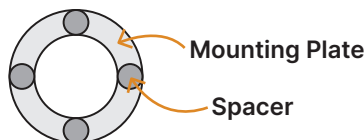

**Contact us to learn more.**



A fire table or bowl can be placed in a soft area (such as gravel or grass) as long as the feet of the fire table or bowl are placed on a solid surface like a 12” square concrete pad or similar - this ensures the feet do not compress down into soft ground.

## AWEIS Installation



**STOP:** The installation should be done by a **Qualified Service Technician** that is **Locally Licensed**

### Step 1 - Preparing the Enclosure

In this set up & instruction set, we will be using a generic non-combustible square enclosure.

#### Gas & Conduit Placement **24VAC** **30VDC** **120VAC**

When placing your enclosure, you want to ensure that the incoming gas line is in the center of your enclosure, this will ensure that the burner will end up in the center of your enclosure. The incoming electrical conduit is of less importance for placement. *See the diagram to the right for an example.*



If your enclosure does not provide enough ventilation, you may need to install risers underneath your enclosure to provide proper ventilation. **This is paramount if you are using Liquid Propane.**

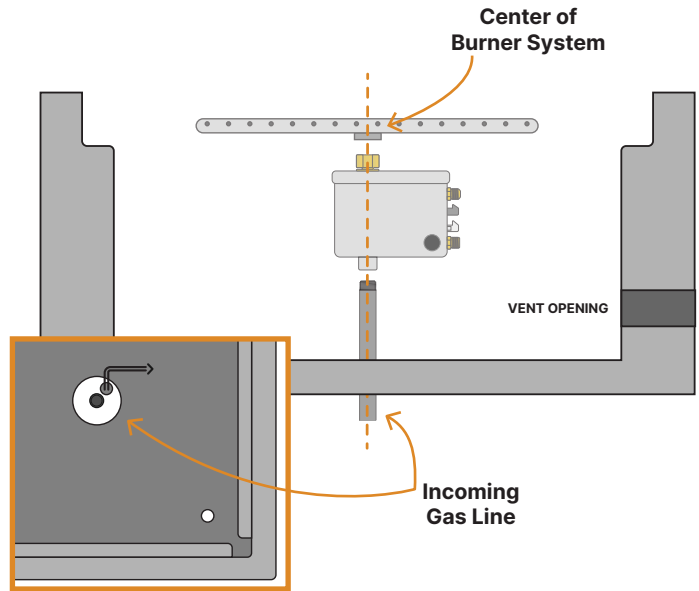

#### Drainage for the Enclosure **24VAC** **30VDC** **120VAC**

Drainage **MUST** be provided in the enclosure. Drainage can be obtained by making holes in the bottom or sides of the enclosure or elevating the enclosure off the mounting surface by way of risers, spacers or similar methods. *This is similar to providing proper ventilation.*

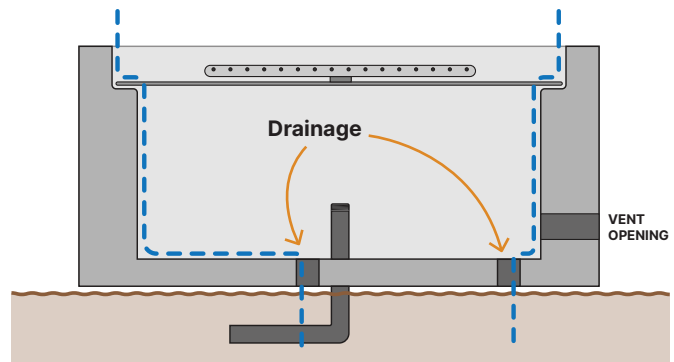

## Step 2 - Attaching the AWEIS Ignition Control Module to the Incoming Gas Line

24VAC 30VDC 120VAC

There are several different methods to connect the AWEIS control box to the incoming gas line. **For the remainder of this installation guide, we are going to use the method of attaching the Control Box directly to the Gas Line / Stub.**

Attached directly to the Gas Line / Stub

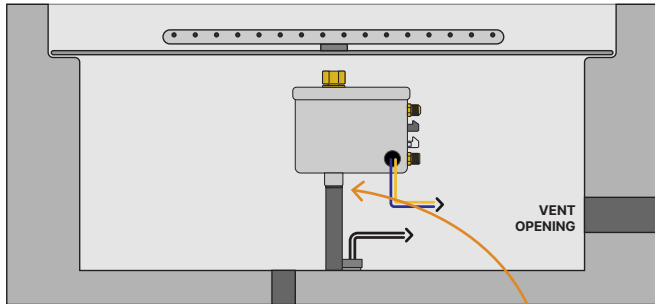

Incoming Gas Line

Apply the pipe dope/tape to the gas stub and thread the AWEIS Ignition Control Box onto the gas riser as shown in the diagram to the right.

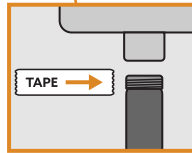

Attached to Gas Line / Stub with Flex Line

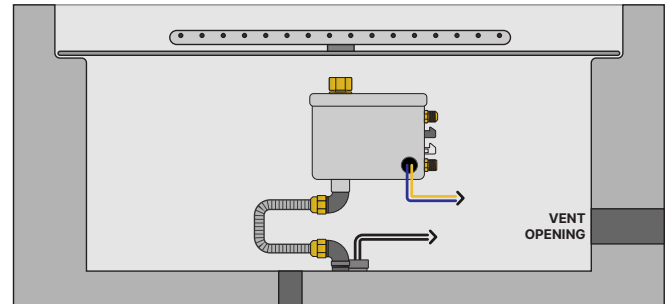

Incoming Gas Line

**Leak Test** – it is highly recommended to perform a gas leak test at this point in the install. Turn on the gas supply and then, using a soapy water solution spray the bottom of the AWEIS where it is connected to the gas line to ensure no leaks exist.

## Step 3 - Connecting the AWEIS unit to a Power Source

24VAC 30VDC

Take the wires that are protruding from the AWEIS and connect them to the two wires from the electrical conduit using appropriate sized wire nuts.

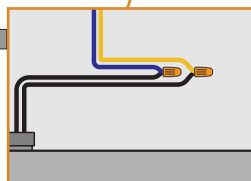
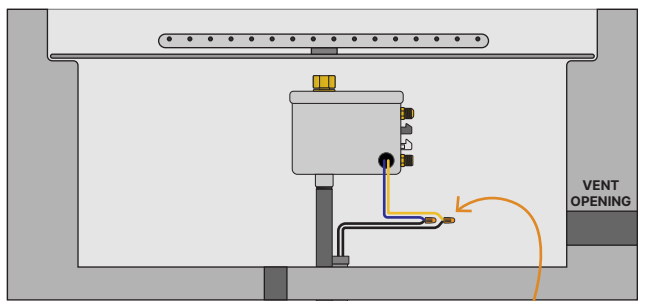

**NOTE:** It is not required but it is recommended to fill the wire nuts with either dielectric grease or silicone prior to installing the wire nut. This will ensure a weatherproof electrical connection.

120VAC

Take the wires that are protruding from the AWEIS and connect them to the two wires coming from the 120VAC adapter. Then plug in the adapter to the outlet

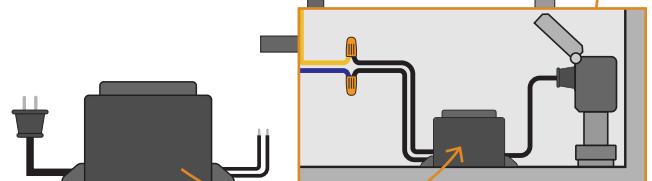
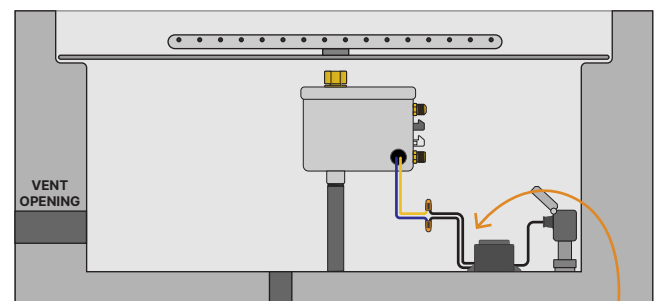

120 VAC Adapter

**NOTE:** The adapter must be plugged into an outdoor approved 120VAC outlet.

## Step 4 - Connecting the AWEIS Pilot Burner Assembly

24VAC 30VDC 120VAC

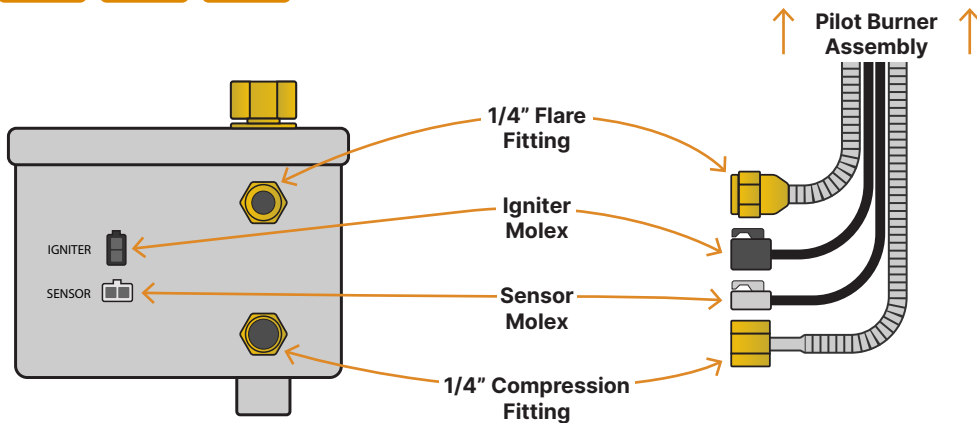

### Igniter & Thermopile Electrical Molex Connections

There are two electrical Molex connectors attached to the Pilot Burner Assembly - **these connectors are different from one another**. Ensure they are connected to the correct port on the Ignition Control Box.

Hardwired models will have on the right side of the AWEIS Ignition Control Module two brass fittings for the Pilot Burner Assembly. It will also have two electrical Molex connectors for the Pilot Burner Assembly. See the diagram above to identify the different parts.

Start by attaching the flare & compression fittings from the Pilot Burner Assembly to the AWEIS Ignition Control Box. Make sure you are attaching the correct lines by referencing the diagram above.

## Step 5 - Attaching the AWEIS Ignition Control Box to the Burner / Pan

24VAC 30VDC 120VAC

In steps 1 - 4 we have been setting up the AWEIS itself - now it's time to attach everything to the pan / burner. But, in order to do that we need to talk about the actual connection from the **Control Box to the Burner via the Gas Orifice**. Each AWEIS system comes with the proper gas orifice (either Natural Gas or Propane) that was selected at the time of purchase.

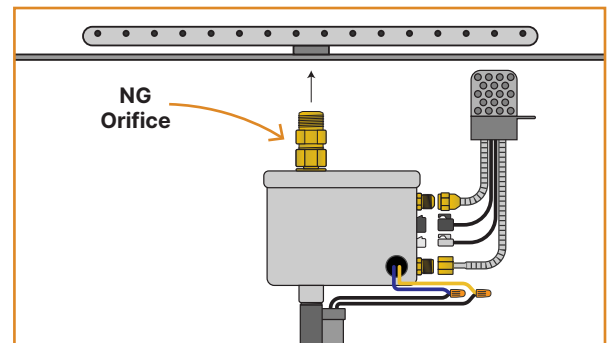
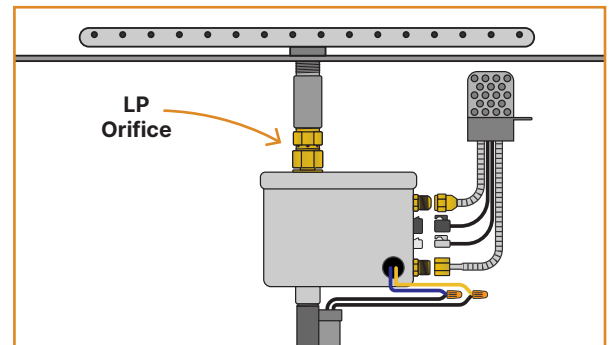
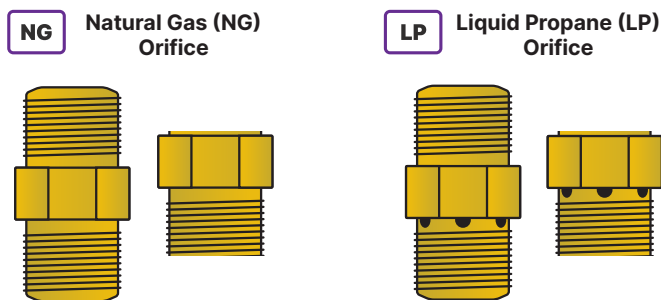

With every fire feature an orifice **MUST** be installed between the outlet of the AWEIS Ignition Control Box and the burner.

When the fuel type is Natural Gas a Natural Gas Orifice is to be installed.

When the fuel type is Propane a LP Air Mixer Orifice is to be installed. The noticeable difference between these two orifices are the 6 Air Holes in the LP Air Mixer orifice.

To ensure proper operation of the LP Air Mixer Orifice it must be configured with a coupling and a pipe nipple as shown in far-right photo. The Natural Gas orifice can be installed without a coupling and pipe nipple.

## Attaching to the Burner Pan

You will need to line up the Opening for the Pilot Burner with the Pilot Burner.

You will notice that the hole in the center of the pan (for the pipe nipple coming from the Ignition Control Box) and the opening for the Pilot Burner are much larger than needed. This is done to make it easier to Install the Burner Pan. The large gaps around the pipe nipple and Pilot Burner will be covered with additional parts (shown to the right side of the image below).

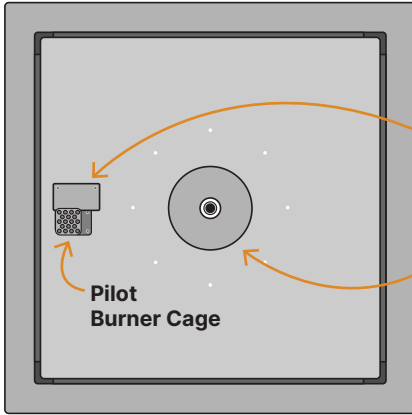
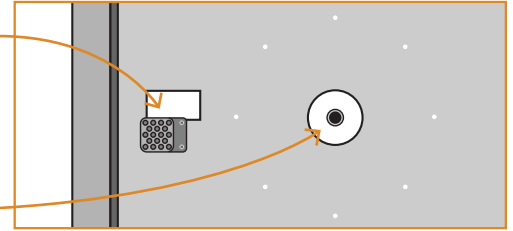

You would have received cover plates (a Rectangle and a Circle - Shown below) along with 4 stainless steel screws (not pictured).

 The rectangle plate is secured to the pan after you have secured the pilot burner to the pan. This prevents media from falling into the enclosure.

 The round plate that covers the excess gap between the pan and the pipe nipple has two smaller holes in it to secure it to the pan using the screws that are provided with the plate. If the pipe nipple is not centered the two smaller holes in the plate may not line up with the matching holes in the pan. It is not required to secure the round plate to the pan but rather recommended. You may have to drill two new holes in the pan to secure the plate to the pan if in fact the holes do not line up.

## You can now install the burner

It is recommended to use Teflon Tape or Pipe Dope on the main burner. Position the burner so that the Pilot Burner Cage is within 2 inches of the burner.

**NOTE:** Please ensure you install the burner so that the end of the spiral burner is placed up against the pilot burner. This is important to ensure proper operation of the unit.

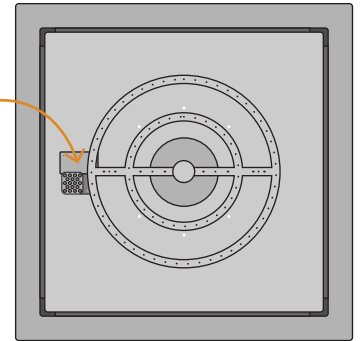
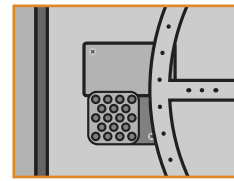

## Installation Safety Backup Valve | LIQUID PROPANE ONLY

**24VAC** **30VDC** **120VAC**

Included in every LP Kit is a Safety Backup Valve. If possible, install this valve in a separate area away from the fire feature and protected from any rain or other weather conditions (either in a control room or landscaping box). It is possible to install this valve in the fire feature enclosure, but it is not recommended.

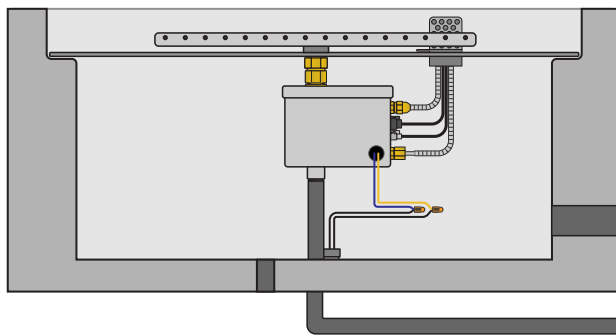

Landscape Box or Control Room



## Remote Positioning of the AWEIS

The AWEIS Box can be installed up to 150ft away from the burner. This can be beneficial for scenarios where excess heat could compromise the AWEIS box.

**NOTE:** If you intend on installing the box past 20ft, please contact Fire By Design for more information.

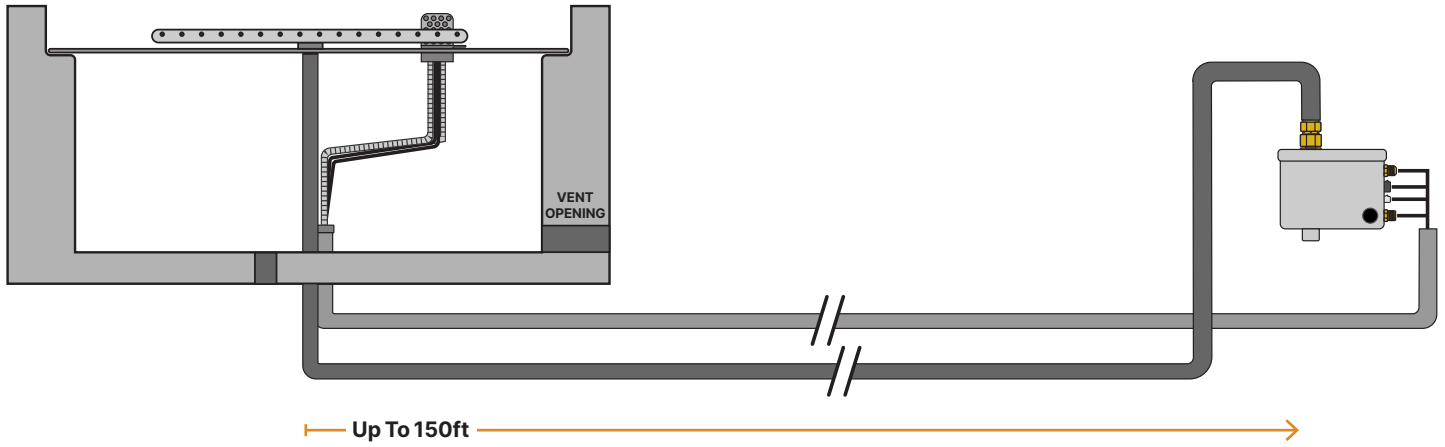

# AWEIS Completed Installation Diagrams

The below diagrams are representations of a final & complete installation of an AWEIS system. The top diagram is for 24/30V Models, and the bottom diagram is for AWEIS units that utilize the 120VAC adapter.

**24VAC** **30VDC**

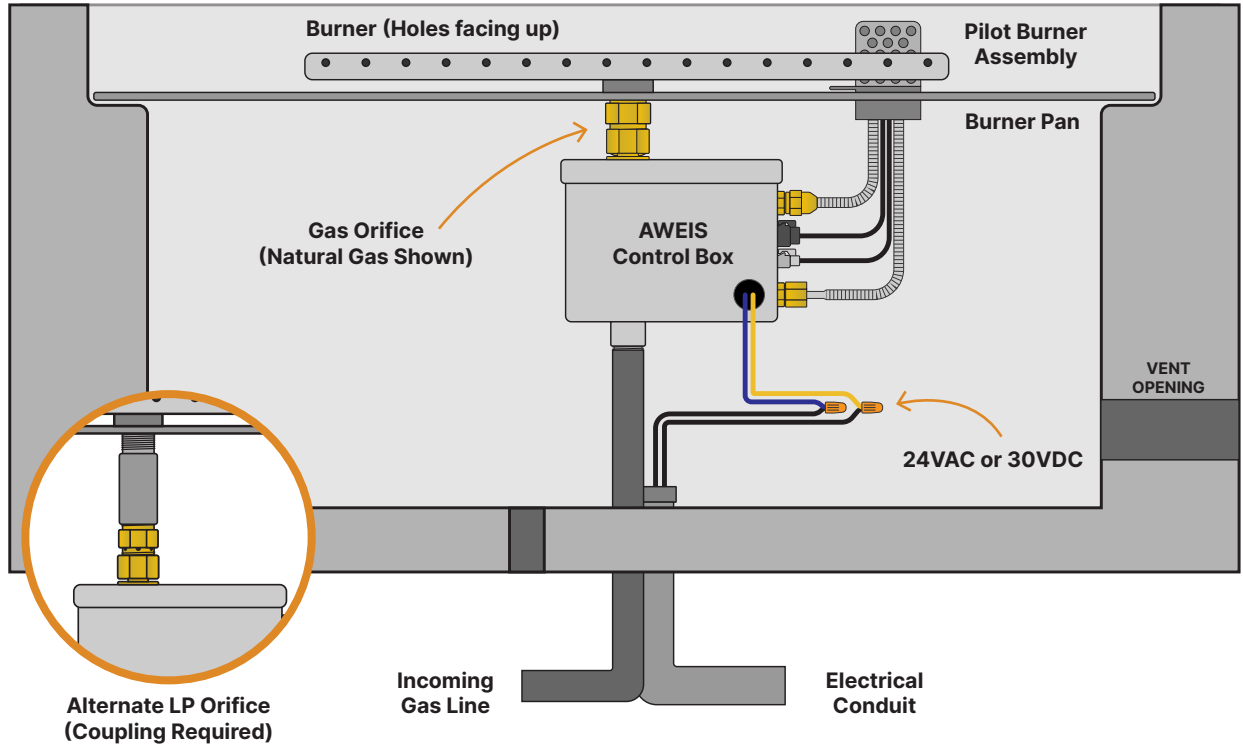

**120VAC**

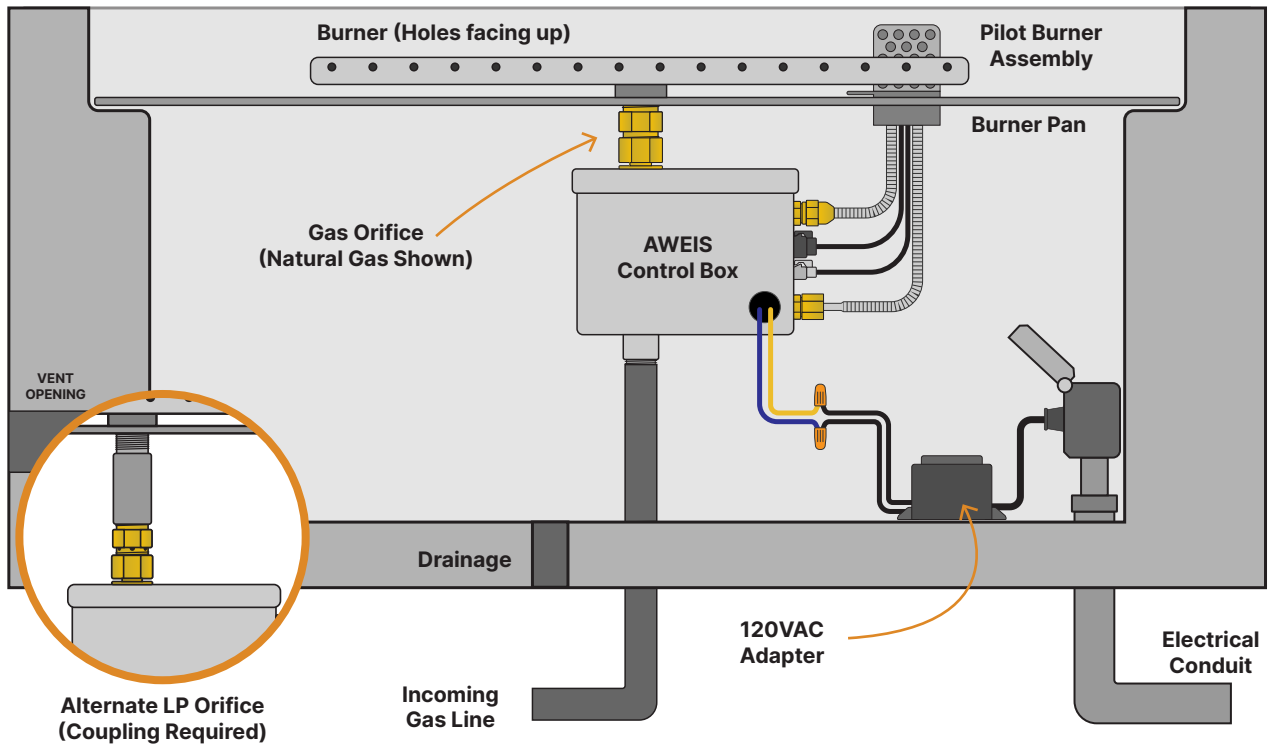

## Operation of the AWEIS Burner System



Do **NOT** use this appliance if any part has been under water.

Immediately call a qualified service technician to inspect the appliance and to replace any part of the control system and any gas control which has been under water.



**HOT! - DO NOT TOUCH - SEVERE BURNS MAY RESULT - CLOTHING IGNITION MAY RESULT!**

Carefully supervise children in same area as appliance. Alert children and adults to hazards of high temperatures. Clothing or other flammable materials should not be hung or placed near the appliance



**WARNING!** This appliance should be inspected before use and at least annually by a **Qualified Service Technician** that is **Locally Licensed**.

Any guard or protective device removed for servicing must be replaced prior to operation. Keep the appliance area clear and free from combustible materials, gasoline and other flammable vapors and liquids.

**24VAC**

**30VDC**

**120VAC**

Prior to turning appliance on, visually inspect the fire feature to ensure debris such as leaves or other combustible material has not collected inside the feature which could burn and emit embers once the fire feature is turned on. Also ensure any person standing close to the fire feature is aware you will be turning the fire feature on prior to actually turning it on.

Turn the fire feature on by turning on the electrical device used to power the fire feature.

**Below is the Sequence of Operation for Hardwired 24/30/120V Models:**

- Power is applied.
- Hot surface igniter (glow plug) becomes hot, and 4 seconds later the Pilot Gas Valve opens.
- Within 10 seconds of power application, the Pilot Flame should be visible (at night only).
- Within 10 seconds of Pilot Flame Ignition, the burner should ignite.

**Fire Feature Shut Down for Hardwired 24/30/120V Models:**

- Turn off the electrical device used to power the fire feature.



**WARNING!**

If fire feature fails to turn off completely (small flames still visible) - Turn off gas supply using the manual gas shut-off.

## Maintenance of the AWEIS Burner System



**WARNING!** Maintenance should be done by a **Qualified Service Technician**. The appliance should be inspected before use and at least annually.

Ensure gas & power are shut off and the appliance is cool before servicing. Any guard or protective device removed for servicing must be replaced prior to operation.

**24VAC**

**30VDC**

**120VAC**

**Prior to Each Use:**

- Inspect for debris in the Fire Feature & inside the enclosure. Remove any debris prior to use.

**Semi-Annually:**

- Visually inspect Pilot Burner for debris / insect infestation (spider webs).
- Visually inspect burner holes for debris / insect infestation.
- Clean either of the above if necessary using compressed air.

**Annually:**

- Visually inspect Pilot Burner for excess corrosion due to heat and moisture.
- Turn fire feature on to ensure proper operation.

## Troubleshooting the AWEIS Burner System

24VAC 30VDC 120VAC



This QR Code will always take you to the most recent troubleshooting guide for the 24/30V Models of our AWEIS System.

You can also type in the URL directly: <http://fbdqr.com/aweis-troubleshoot>

## Replacement Parts for the AWEIS Burner System

24VAC 30VDC 120VAC

Identifier	Part #	Description
A	PBA	Pilot Burner Assembly
B	ICB	Ignition Control Box
C1	50VA-24VAC	24VAC Transformer
C2	PS-30V185	30 VDC Power Supply
D	SPBG	Secondarily Pilot Burner Gas Line
E	PPBG	Primary Pilot Burner Gas Line
F	PBO	Pilot Burner Orifice
G	PBC	Pilot Burner Cage
H	TP	PBA Thermopile
I	HSI	PBA Hot Surface Igniter
J	120 VAC PS	120V Adapter

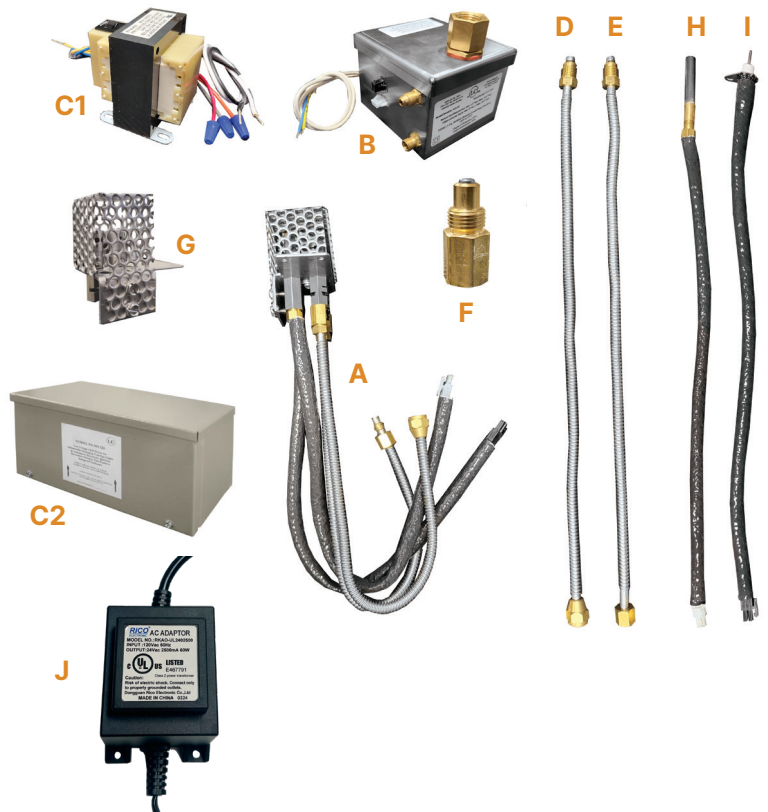

### Replacement Part Installation Instructions

This QR Code will always take you to the Field Serviceable AWEIS Replacement Parts Install Instructions. You can also type in the URL directly: <http://fbdqr.com/fs-aweis-replacement-inst>

# Automated Pool Controller Wiring

## 24VAC Wiring to Pool Controller when 2 Features Turn ON at the same time | 24 Volt AC Systems

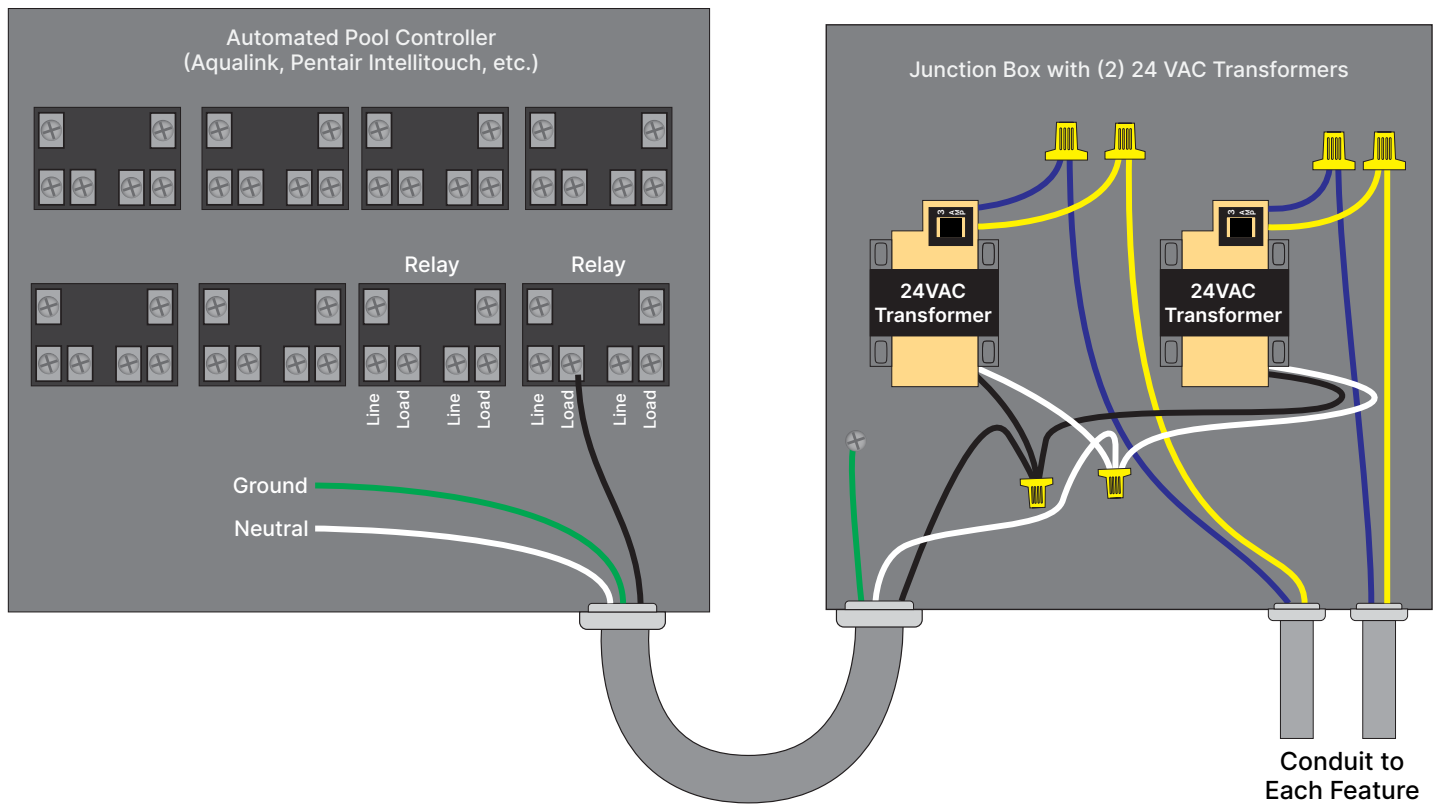

## 24VAC Wiring to Pool Controller when 2 Features Turn ON Separately | 24 Volt AC Systems

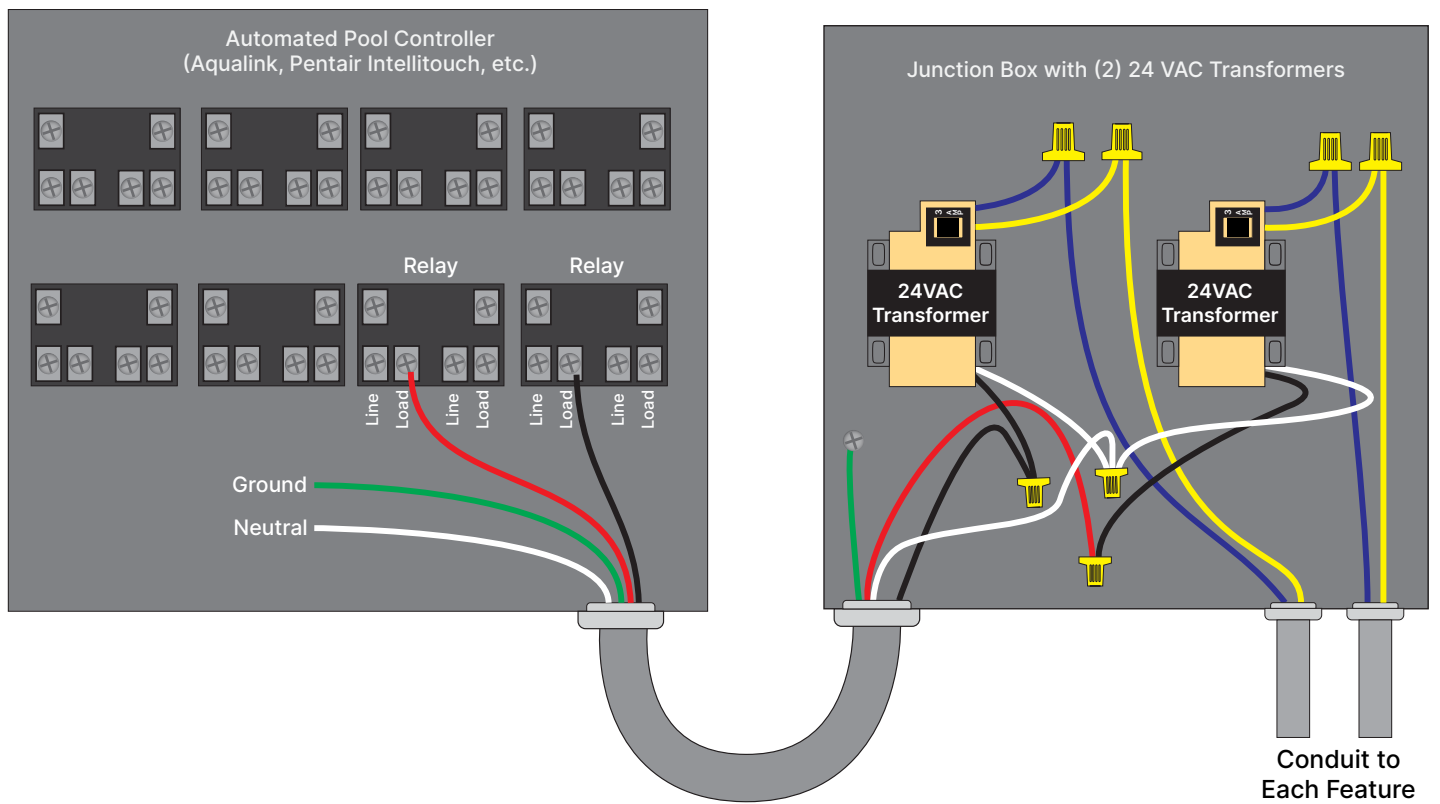

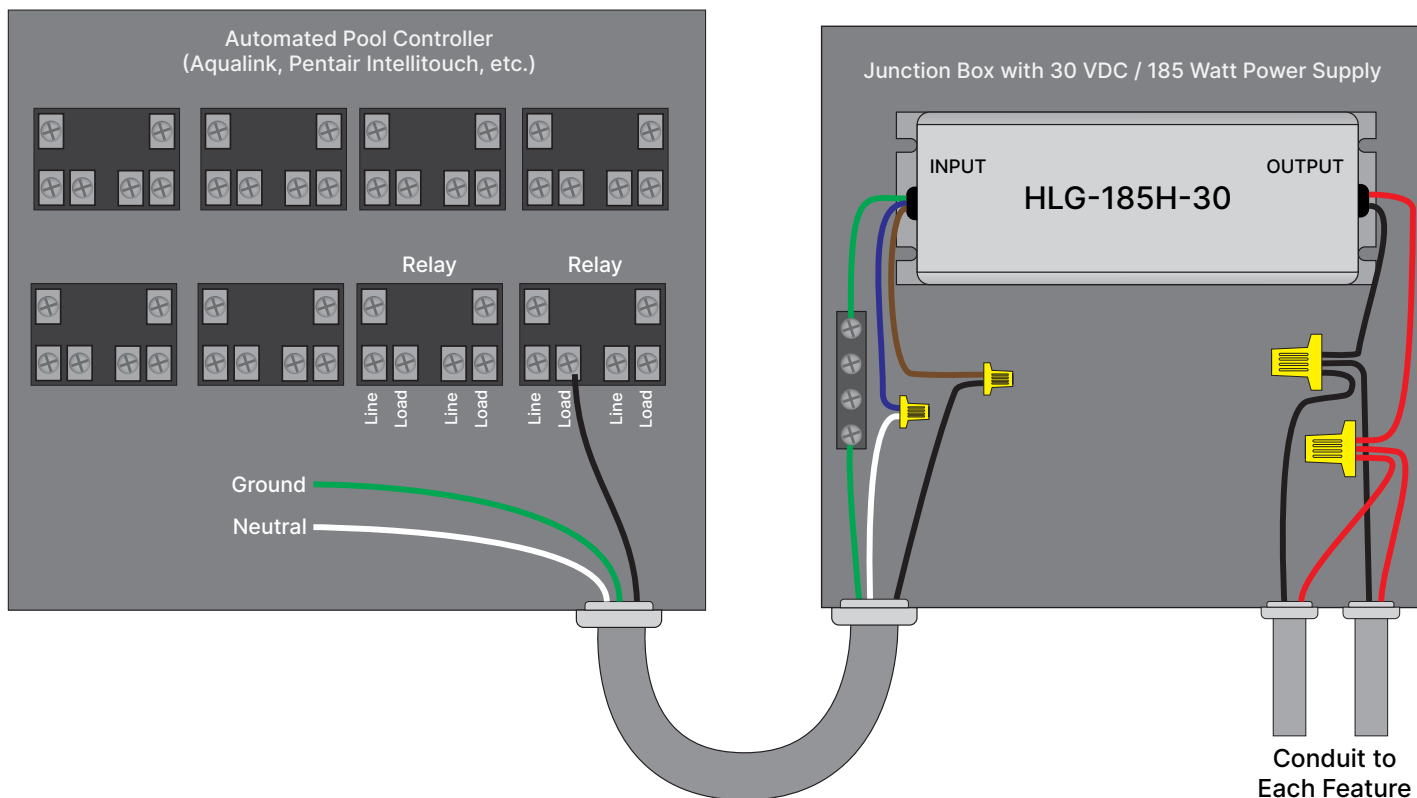

**NOTE:** In order to turn 2 or more feature ON separately, EACH fire feature requires its own 30 VDC Power supply. One 30 VDC Power Supply is shown above.

## Media Information & Installation



**WARNING!** Do not use any other material as filler/topping media inside fire features other than those listed below. Using improper media inside a fire feature could result in damage to property or injury to persons nearby due to media “popping” or “exploding” due to heat.

### List of Acceptable Media:

- Lava Rock (or other Igneous Rock) - No larger than 2” in diameter.
- Fireglass approved for use in fire features.
- Man-made Stone for use in fire features (Refractory Material).

### MEDIA INSTALLATION NOTE

The use of media inside fire features is recommended due to the fact it enhances the look of the fire feature but also improves its performance by forcing the gas emanating from the burner to mix as it passes through the media. This ‘mixing’ of gases creates an even flame throughout the feature and helps spread the flame from the Pilot Burner throughout the burner quicker than when there is no media.

Recommended thickness of the media above the burner element is NO MORE than 2”. Due to the fact the Pilot Burner must be partially exposed to oxygen in order to ignite the pilot flame during startup **DO NOT COMPLETELY COVER THE PILOT BURNER.**

When installation of the media is complete the top of the Pilot Burner Protective Cover should be visible.



### NOTE | MEDIA MUST BE PRESENT!

Media (ie: Lava Rock or Fireglass) must **at least** be present in and around the pilot burner. If no media is present, the system may repeatedly cycle on and off. The media acts as a windbreak for the system.

## Lava Rock Installation

The size lava rock in this visual example is 2" in diameter.

The picture on the far right is a close up of the Pilot Burner. Notice it is barely visible in either of the photos.

When using smaller lava rock you may not be able to cover it as well due to the fact the smaller rock may "smother" the Pilot Burner and prevent oxygen from getting to it.

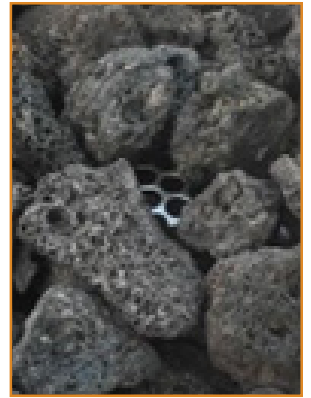

## Fireglass Installation

The size fireglass used in visual example is 1/2" in diameter.

The picture on the far right is a close up of the Pilot Burner. Notice it is barely visible in either of the photos.

When using smaller fireglass you may not be able to cover it as well due to the fact the smaller rock may "smother" the Pilot Burner and prevent oxygen from getting to it.



## Return Policy

---

All orders from Fire by Design (FBD) may be returned within 30 days for a full refund. In order to return or exchange (under the warranty guidelines described in the **Fire by Design Limited Warranty** section of this instruction set) all or part of your order, you must contact us for a Return Merchandise Authorization number (RMA#). Call toll free (877) 807-8923 to obtain an RMA# from a FBD representative.

All returned merchandise must be in the original packaging including manuals, accessories, cables, etc. with the authorization (RMA#) clearly printed on the outside of the package. Return requests must be made within 30 days of the receipt date. Any shipping and/or handling charges on the original order cannot be refunded. At our discretion, we may levee a restocking fee of 15% of the cost of items returned.

FBD is not responsible for shipping costs or damage on returned items. Units to be returned should be packed carefully. Please be advised that packages sent by normal US Postal Service cannot be tracked to ensure delivery.

Since FBD cannot provide credit for a return without confirming its receipt, we recommend that you use a delivery service that can be tracked and or insured.

## Fire by Design | Limited Warranty

---

Fire by Design warrants its products to be free from defective material and workmanship for the period of time indicated below for each product line. The warranty time periods listed below are from the original date of purchase. Fire by Design agrees to repair or replace, at its sole discretion, a defective product if returned to Fire by Design within the warranty period and accompanied by proof of purchase. This warranty does not extend to any Fire by Design products which have been subject to misuse, neglect, accident, incorrect wiring or to use in violation of operating instructions furnished by us, nor extend to any units altered or repaired for warranty defect by anyone other than Fire by Design. This warranty does not cover any incidental or consequential damages and is in lieu of all other warranties expressed or implied and no representative or person is authorized to assume for us any other liability in connection with the sale of our products. Some states do not allow limitations on how long an implied warranty lasts, and/or the exclusion or limitation of incidental or consequential damages so the above limitations and exclusions may not apply to the original CUSTOMER. This warranty gives you specific rights and you may also have other rights, which vary, from state to state. If you have any questions concerning this warranty call (877) 807-8923.

### **Bowls**

All Decorative GFRC, Stainless, Copper or Aluminum Bowls are warranted for (2) years from delivery date against any manufacturing defect or structural failure. Small stress cracks and surface crazing are a natural occurrence in concrete and not covered by warranty.

### **Fire Rings**

All 304 Stainless Steel Rings are warranted for (3) years. 316 Stainless Steel Burners (Marine Grade) have a Lifetime Warranty.

### **Burner Pans**

All 304 Stainless Steel Burner Pans warranted for (5) years. All Aluminum Burner Pans have a Lifetime Warranty.

### **Electronic Ignition Systems (Field Serviceable AWEIS SC, HC, XHC, SUBEIS, BP AWEIS)**

All Field Serviceable AWEIS and SUBEIS systems are warranted for (1) year from date of purchase for Commercial Applications and (3) years from date of purchase for Residential Applications provided the product has not been modified, abused, misused or improperly installed, maintained or repaired during such period. Fire by Design, at its discretion, will either repair or replace the defective product. If one of the Field Serviceable parts of an AWEIS or SUBEIS fails a replacement part will be provided at no charge to the customer. Labor cost to replace the failed field serviceable is not covered under this warranty. If a part other than a Field Serviceable part fails that part will be replaced or repaired at no charge to the customer.

### **Vulcan Fire Module & Tiki Torches**

Vulcan Fire Modules and Automated Tiki Torches are warranted for (1) year from the date of purchase.

The original purchasing information such as an invoice or product serial number is required on all warranty returns.